



Instruction Manual BS EN 1004-2:2021-EN
The ALTO MD Ladderspan Tower is certified to BS EN 1004-1:2020

3T - Through The Trapdoor Method



Introduction

Please read these instructions carefully and ensure that you fully understand all of the information contained herein. All of the information in this document is vital for the safe utilisation of your Alto Medium Duty Tower, which is designed primarily for the safe execution of tasks such as construction and maintenance work at platform heights of between 3m and 12m.

All Alto Access products are professional quality engineered equipment designed primarily with safety in mind and meet or exceed all standards, recommendations and guidelines. Used properly, Alto access equipment will keep you safe when working at height.

This manual contains all of the information necessary to correctly assemble your Alto Medium Duty mobile access tower and incorporates all of the requirements of the PASMA 3T method of assembly as endorsed by the HSE.

This manual should be used in conjunction with your Risk Assessment and Method Statement and in line with the Work at Height Regulations 2005 which place an obligation on employers to eliminate or minimise risks. This manual must be made available to the user/assembler at all pertinent times.

Only competent and qualified personnel should undertake erection, dismantling or alteration, organisation, planning or supervision of mobile access towers. In the case of any doubt, sufficient relevant additional training must be given beforehand to ensure safe use. For further information on the use of mobile access towers consult PASMA (www.pasma.co.uk; Tel +44 (0) 845 230 4041). For any additional technical information or specific advice please contact the manufacturer Lakeside Industries Limited Tel: +44 1527 500577 or Email: sales@altoaccess.com.

Certifications

The Alto Medium Duty Tower is a mobile access tower certified to BS EN 1004-1:2020 Load Class 3. If the application is outside the scope of BS EN 1004-1:2020, reference should be made to BS 1139-6:2022 to ensure that the configuration of the equipment meets the relevant requirements. This tower is manufactured in our ISO 9001 accredited facility. This manual complies with BS EN 1004-2:2021.

Maximum Safe Working Loads

The safe working load of the tower is 2,000kg including its own weight. The maximum safe working load of any individual platform is 282 kg evenly distributed. The maximum number of persons permitted on a platform unit within a working platform is two.

The maximum permitted horizontal force at the working platform for a freestanding Alto Medium Duty tower is 30kg. It is a requirement of BS EN 1004-1:2020 that a tower may only have one working platform at a time. If the tower is to be used in an application outside the scope of BS EN 1004-1:2020, contact your supplier or the manufacturer, Lakeside Industries Limited, for advice on loadings. Tel: +44 1527 500577 or Email: sales@altoaccess.com.

Inspection Care & Maintenance

Alto Access equipment is designed and manufactured to the highest standards in the industry and is stronger, more robust and safer than any comparable competitor product. Properly cared for, it will give a long and productive service life.

The equipment should be inspected and maintained by a competent person as outlined in the "Alto MD Tower Inspection Procedures". A free downloadable copy is available at www.altoaccess.com/downloads.

- Equipment should always be inspected before and after each use.
- Whilst Alto Access equipment is extremely robust, care should be exercised in loading, transporting and handling components to avoid damage or injury to either the equipment or persons.
- Never use any equipment which is damaged, has parts missing or is improperly assembled.
- Repairs should only be carried out by Lakeside Industries Limited or their authorised repairers.
- In case of any doubt as to the integrity of any items of Alto Access equipment, the part should be withdrawn from use, quarantined and subject to detailed examination to determine whether repair or replacement is required. If returned to the factory, Lakeside Industries Limited will provide a free of charge evaluation of any damaged components.

Safety

This instruction manual shall be available on the location of use of the mobile access and working tower. This mobile access and working tower shall only be used according to this manual without any modification. Mobile access and working towers must only be used in accordance with national regulations. The permissible configurations of the tower are set out in the tables of components on pages 14 and 15 below. These set out the permitted heights and the required components.

Check that all of the necessary components and equipment for the particular tower configuration to be built are on site, undamaged and functioning correctly. Damaged or incorrect components shall not be used. Only the original Alto Access Products components specified in this manual shall be used.

Always consider the correct platform height in relation to the required working height and the task to be carried out when selecting and assembling a tower. Before assembling the tower, the location should be checked to identify and eliminate hazards during assembly, alteration and dismantling. In particular:

- Check that the surface on which the tower is to be located is capable of supporting the tower and its payload. Check that the level and slope of the ground do not render the location unsafe for the purposes of assembling, using and dismantling the tower.
- The place in which the tower is to be assembled and deployed should be segregated from the rest of the site using appropriate barriers and warning signs. This is to reduce or eliminate the risk of unauthorised persons walking close to or under the tower and of vehicles or plant colliding with the tower.
- Beware obstructions when assembling, altering and dismantling the tower.
- When working outdoors, the weather forecast shall be taken into account before assembly, use and dismantling.
- Beware live electrical installations, cables, moving machinery or other obstructions when erecting, dismantling or using the tower. The tower is a conductive metallic structure.
- The safe working load of the tower is 2,000kg including its own weight. The maximum safe working load of any individual platform is 282 kg evenly distributed.
- This product shall only be used according to the instruction manual.
- User training courses cannot be a substitute for instruction manuals but only complement them.
- If the tower is to be used in an application outside the scope of BS EN 1004-1:2020, contact your supplier or the manufacturer, Lakeside Industries Limited, for advice on loadings. Tel: +44 1527 500577 or Email: sales@altoaccess.com.
- Towers must always be climbed from the inside using the built in ladders only. Do not climb the outside of the tower. If the work carried out from the tower requires frequent carrying of equipment and materials up or down the tower, an Alto stair tower should be used in preference to a ladderspan tower.
- The tower must be levelled to within an inclination of 1% when erected using the adjustable jack or castor legs.
- Two or more persons are required for the safe erection and dismantling of a tower.
- Appropriate PPE and a spirit level are required for the safe erection and dismantling of a tower.
- Always comply with the Work at Height Regulations 2005 when erecting, dismantling & using the tower.
- When lifting components, always use reliable lifting equipment and fastening methods and always lift from within the footprint of the tower structure to prevent risk of the tower overturning.

- Users must be aware of the effects of horizontal and vertical loads on the structure when using the tower which may impair the stability of the tower. Examples would be loads resulting from work on an adjacent structure or wind loads which may be increased by tunnelling effects around adjacent buildings.
- See “Moving the Tower” below for safety guidelines affecting the relocation of the tower.
- The maximum permitted horizontal force at the working platform for a freestanding Alto Medium Duty tower is 30kg.
- Do not use boxes, ladders or other items to gain additional height.
- Do not stand on guard rails for any reason.
- If the tower is to be used in connection with hoisting arrangements, this is outside the scope of BS EN 1004-1:2020 and requires specific advice from the manufacturer to ensure safety. Contact the manufacturer Lakeside Industries Limited for advice on loadings Tel: +44 1527 500577 or Email: sales@altoaccess.com.
- Mobile access and working towers designed in accordance with EN 1004-1 are not anchor points for personal fall arrest equipment unless they are specifically designed in accordance with relevant European standards by the manufacturer for that purpose.
- Fit guard rails to all platforms and ensure all wind latches are engaged at both ends of all platforms.
- Stabilisers shall always be fitted when specified.
- Working is only permitted on a platform with complete side protection including guardrails and toeboards.
- The distance between platforms shall not exceed 2.25m.
- Mobile access towers in accordance with EN 1004-1 are not designed to be sheeted. Sheeting massively increases wind loads on the structure.
- If sheeting is to be attached, contact the manufacturer Lakeside Industries Limited for advice on loadings Tel: +44 1527 500577 or Email: sales@altoaccess.com.
- Mobile access towers in accordance with EN 1004-1 are not designed to be lifted or suspended. If a tower is to be lifted or suspended, contact the manufacturer Lakeside Industries Limited for advice on loadings Tel: +44 1527 500577 or Email: sales@altoaccess.com
- Mobile access towers in accordance with EN 1004-1 are not designed to be used as a means of edge protection.
- Mobile access towers in accordance with EN 1004-1 are not designed to be used as a means to enter or exit other structures, e.g. as a stair tower. If a tower is to be used as a means to enter or exit other structures, contact the manufacturer Lakeside Industries Limited for advice on loadings Tel: +44 1527 500577 or Email: sales@altoaccess.com.

- Every erected tower must be inspected by a competent person at least every seven days and any tower which has been left unattended should be inspected before use to ensure that:
 1. No components have been removed or relocated incorrectly;
 2. The castors are locked by the brakes
 3. The tower is still vertical; and
 4. No environmental or other factors have arisen which will influence safe use of the tower.

Alto Access Products recommends the use of the PASMA TowerSure inspection system. For more information, please visit: pasma.co.uk/towersure.

Unattended Towers

To prevent use by unauthorised persons of complete or incomplete towers when unattended, steps should be taken to prevent unauthorised access. Appropriate steps may include some or all of the following:

- Use of scaffold alarms.
- Suitable physical means such as barriers or site fencing to prevent access to the area immediately around the tower.
- Warning signs identifying the areas where access is not permitted should be displayed at the access points to area occupied by the tower.
- Attaching a well-designed and correctly fitted ladder guard to the lowest levels of the tower.
- Appropriate site security.
- Unattended towers should be tied in to a rigid structure.
- Towers which have been left unattended should be inspected before use as outlined above.

Moving The Tower

Always assess the risks before moving any tower. If there is any doubt as to the safety of the move, the tower must be dismantled before moving. Before moving the tower, its overall height should be reduced to 4m working platform height or less. No persons, tools, equipment or materials shall be permitted to remain on the tower when it is being moved.

The tower should only be moved by manually pushing it by the lowest frames at no more than walking speed. When moving the tower users are to be particularly careful of the following:

- Obstructions, including overhead obstacles, moving machinery or electrical cables and equipment.
- Not to move the tower in wind speeds of 18mph (force 5) or above.
- The effect of rough, uneven or sloping ground on the stability of the tower. Towers may only be moved on flat and solid ground without obstacles having a maximum slope of 3%.
- Only to raise the stabilisers by no more than 25mm.
- Locking and unlocking the castors using the foot pedal to allow and prevent the tower moving at appropriate times.

After completing the movement and before every use of the tower the following checks should be carried out as a minimum:

- Ensure that the tower is vertical within an inclination of 1% by using the adjustable jack or castor legs and safely supported on an appropriate surface.
- Check that the tower is correct and complete including the presence and positioning of stabilisers.
- Stabilisers must be positioned in accordance with the manual. Ensure that the couplers are fully tightened to give a reliable grip on the tower frame. Ensure that the stabilisers press firmly against the ground.
- Check that no environmental changes have occurred which influence or affect safe use of the tower.

Wind Speeds

Persons using or responsible for towers must beware of the effect of wind on the structure. Wherever possible, as a precaution, it is advisable to tie the tower in to a rigid structure if it is to be used where it is exposed to potential windy conditions. Users should beware the potential tunnelling effect of open ended or unclad buildings and narrow openings between buildings. We recommend that the use of the tower is discontinued in conditions where the wind speed is above 17mph (force 4).

WIND DESCRIPTION	BEAUFORT SCALE	AVERAGE SPEED	INFORMATION
Medium Breeze	4	13-17 mph	Safe to work on tower.
Strong Breeze	6	25-31 mph	Tie the tower to a solid structure. Do not work on tower.
Gale Force	8	39-46 mph	Towers must be dismantled. Towers must not be assembled.

Erecting & Dismantling the Tower

All Alto towers must be built and dismantled in accordance with the step by step instructions in the following pages corresponding to the particular tower configuration involved and having regard to the Work at Height Regulations 2005; PUWER and Health & Safety legislation as appropriate.

3T Method Explained

The “3T” or “through the trapdoor” method is one of the two permitted ways of assembling a tower without the assembler being at risk of falling. This tower is a 3T tower.

Step 1:

As each new level of platform is installed, the operative takes up a working position in the trap door of the platform, standing on the ladder and leaning back against the edge of the trapdoor aperture.

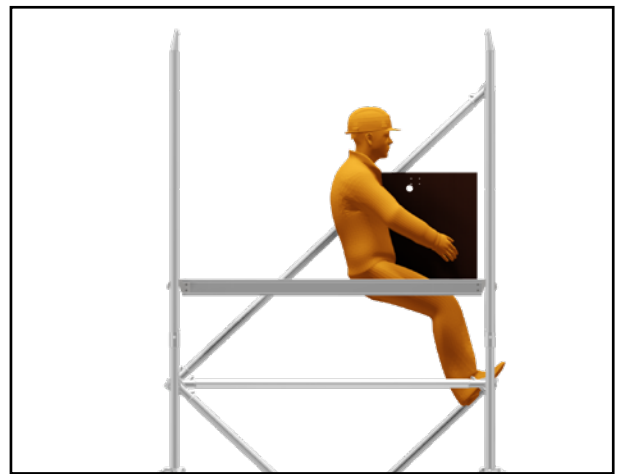

Step 2:

From this position, the operative fits the horizontal braces 500mm and 1000 mm above the platform level (i.e. on the 2nd and 4th rungs above the platform). If the far end of the guardrail braces don't fully engage when they are put in place, the operative fully engages it when first climbing up onto the platform. This process ensures that operatives never have to stand on an unguarded platform.

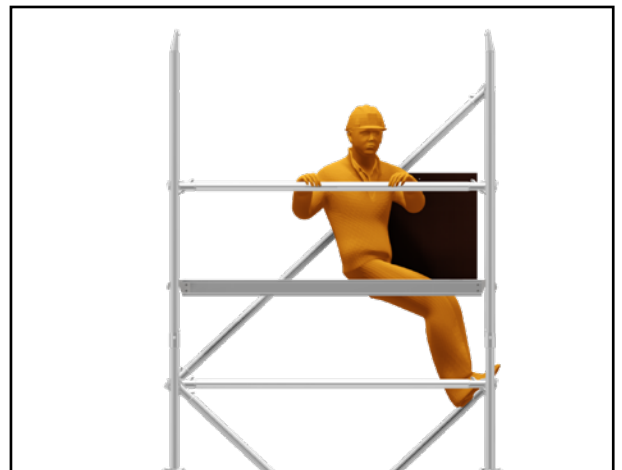

Frames

Frames **must** always be assembled with the offset conical head fitting pointing inwards towards the centre of the tower.

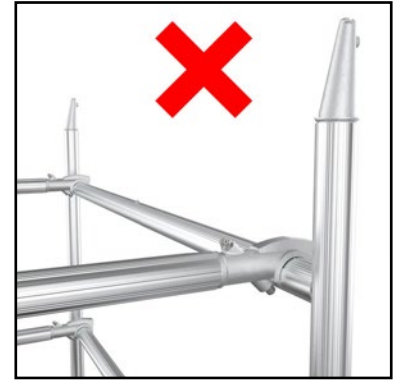

Braces

All braces are fitted with spring loaded pins that automatically lock the brace into position when attached to a tower. Brace hooks **must** be located either over the rung screw heads, between 2 screw heads or between the frame upright and a screw head to prevent lateral movement.

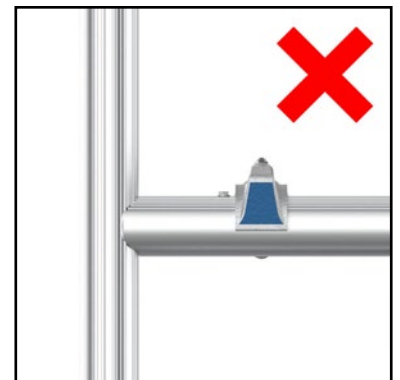
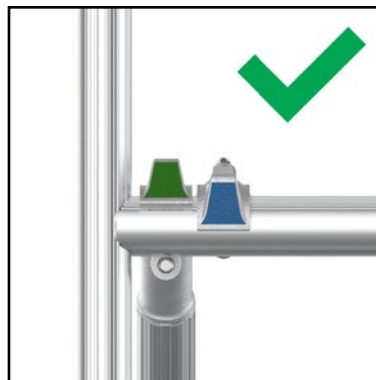

Diagonal braces **must** always be located with the claw opening facing down. Horizontal braces must be located with the claw facing either down (on the rung) or outwards (if on the upright).

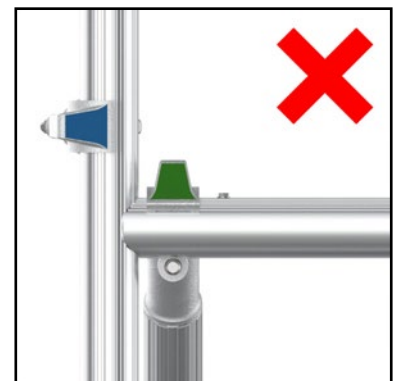
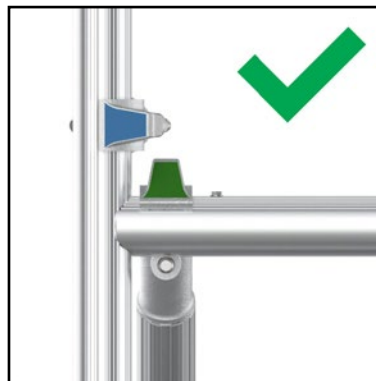

Stabilisers

Stabilisers should always be attached to the tower so as to maximise the base area of the tower structure. The correct size stabilisers must always be used – see component schedule for details.

Stabilisers are attached to the tower using the half couplers on the stabiliser. Once the correct positioning of the stabilisers as outlined below has been achieved, ensure that the couplers are fully tightened to give a reliable grip on the tower frame. Ensure that the stabilisers press firmly against the ground.

In an open area, set the stabilisers so they form a square around the tower as per the diagram below.

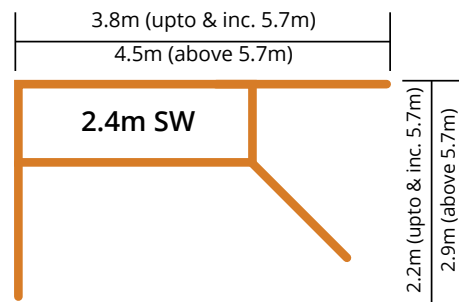
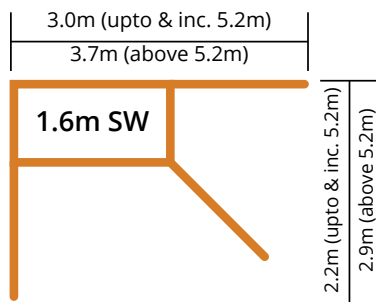
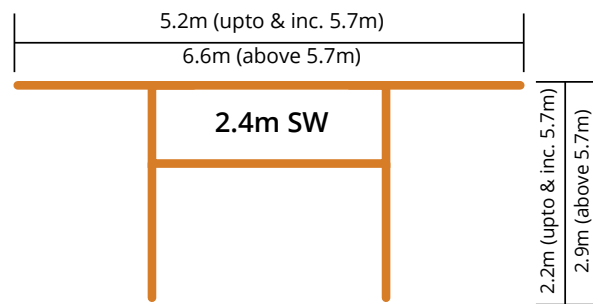
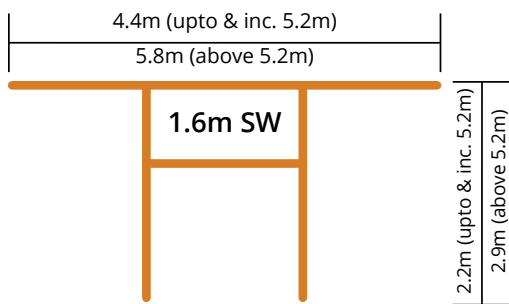
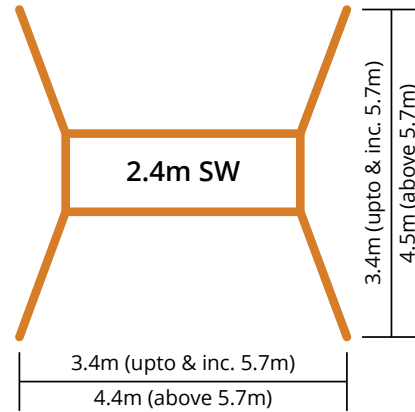
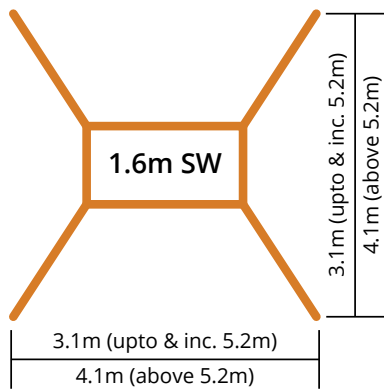

If the tower is being used against a wall, arrange the two stabilisers nearest the wall to run parallel to the wall and the other two stabilisers perpendicular to the tower as per the middle diagrams.

If the tower is being used in a corner, remove the one stabiliser in the corner, arrange the two stabilisers nearest the wall to run parallel to the wall and position the final stabiliser 45 degrees to the tower as per the bottom diagrams.

Where there is insufficient clearance to fit the specified stabilisers, contact your supplier or the manufacturer for specific advice. Where ballast or kentledge is used, it must be of solid material, placed on a platform on the lowest rung of the tower and secured against unauthorised removal.

Tying In

Towers must be tied into a suitable rigid structure once they go beyond the freestanding working heights specified in BS EN 1004-1:2020 - 8m working platform height outdoors and 12m working platform height indoors - or if the tower is unstable or is in danger of being unstable. Standard scaffold tubes and fittings can be used with Alto Access tower products. Ties should be spaced at no more than 4m intervals. Ties must be rigid in tension & compression and be secured to both frame uprights. For further details regarding tying in, please contact your supplier or the manufacturer: Lakeside Industries Limited.

Signage

After assembly or alteration, the following minimum information shall be displayed on the mobile access and working tower and be clearly visible from the ground (e.g. on a tag):

- The name and contact details of the responsible person.
- If the tower is ready for application or not.
- The load class and the uniformly distributed load.
- If the mobile access and working tower is intended for indoors use only.
- The date of assembly.

Safety Pictograms

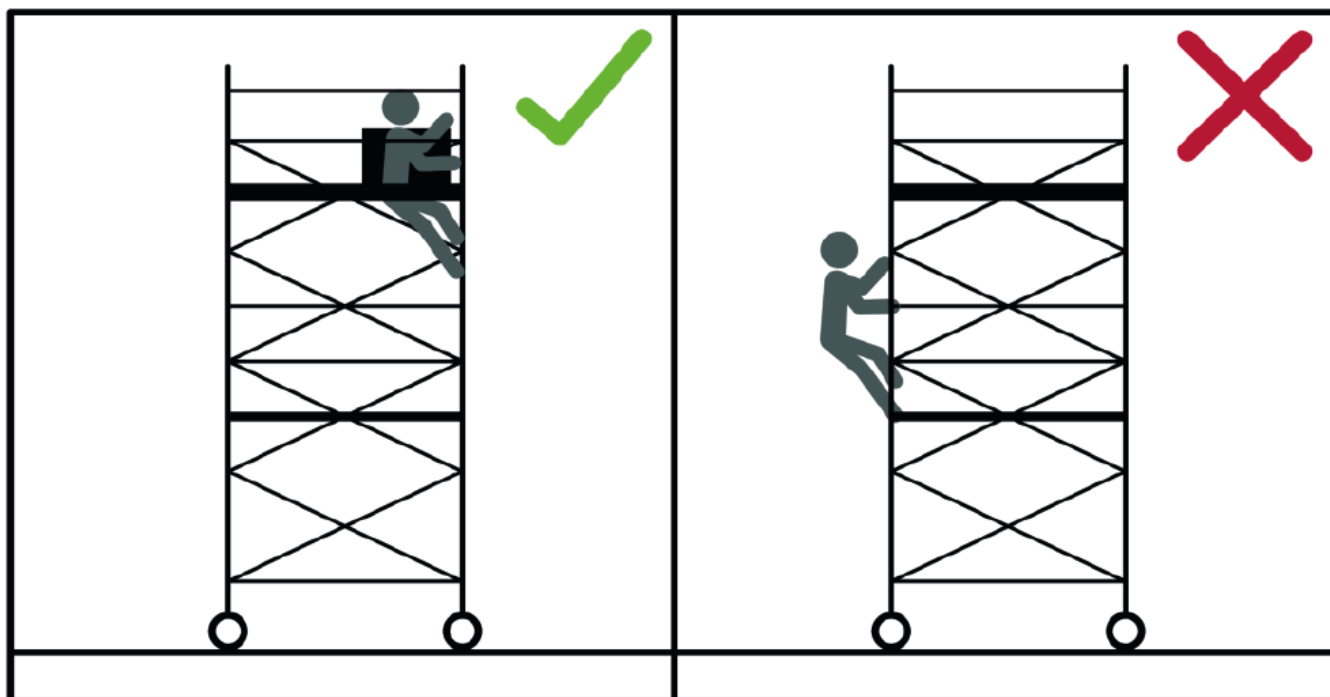

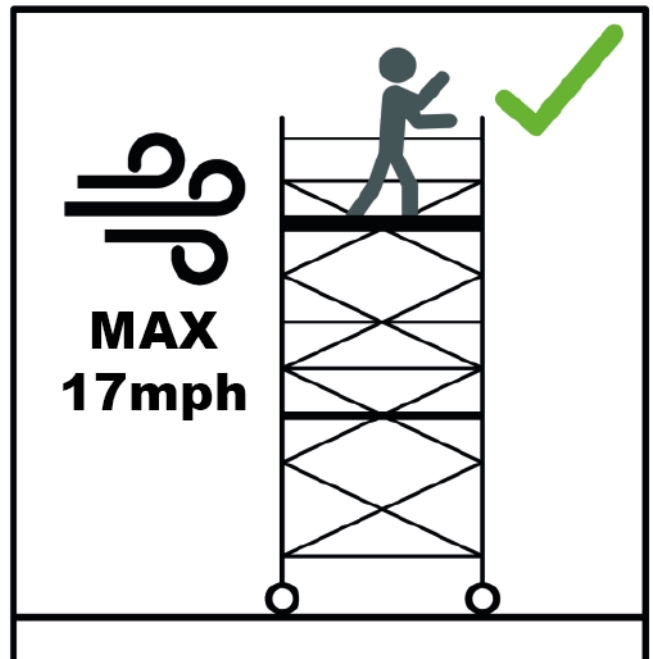
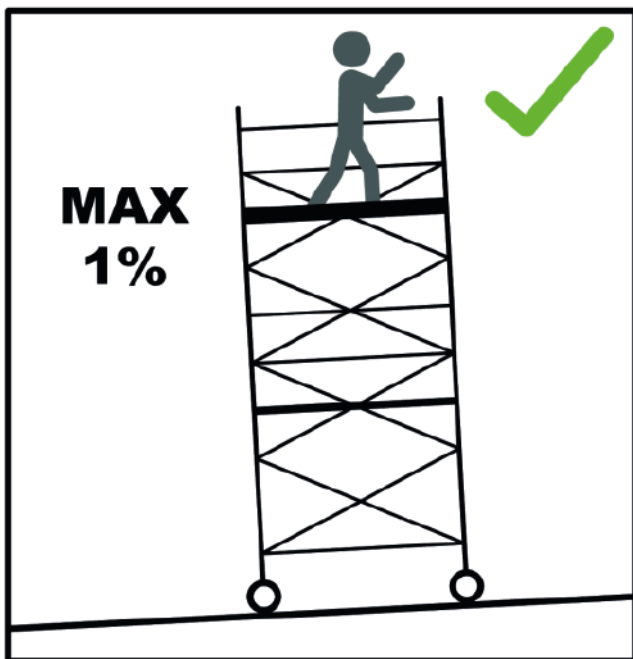
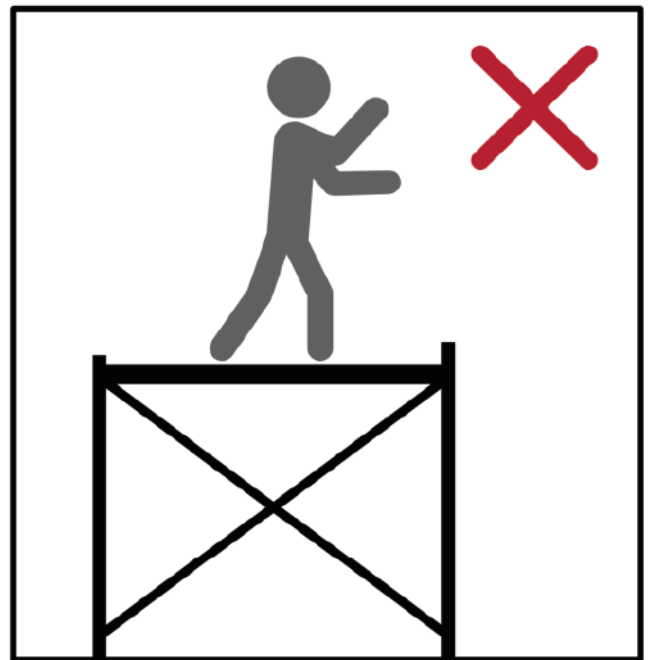

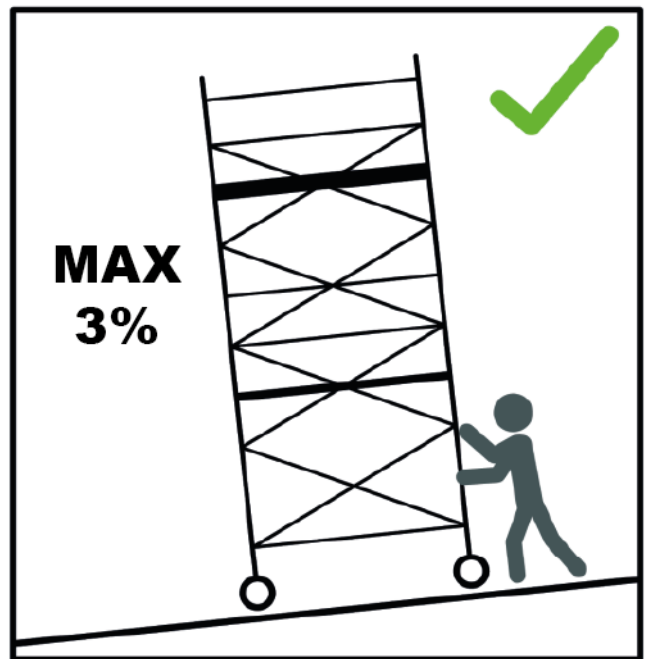
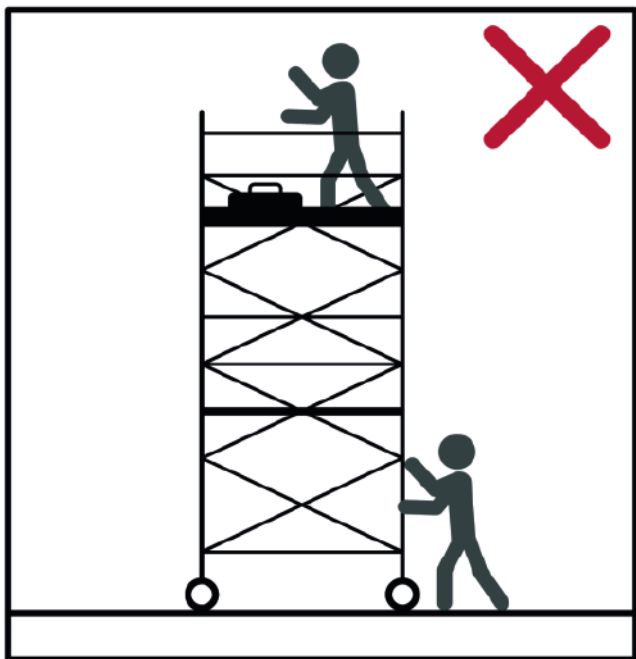
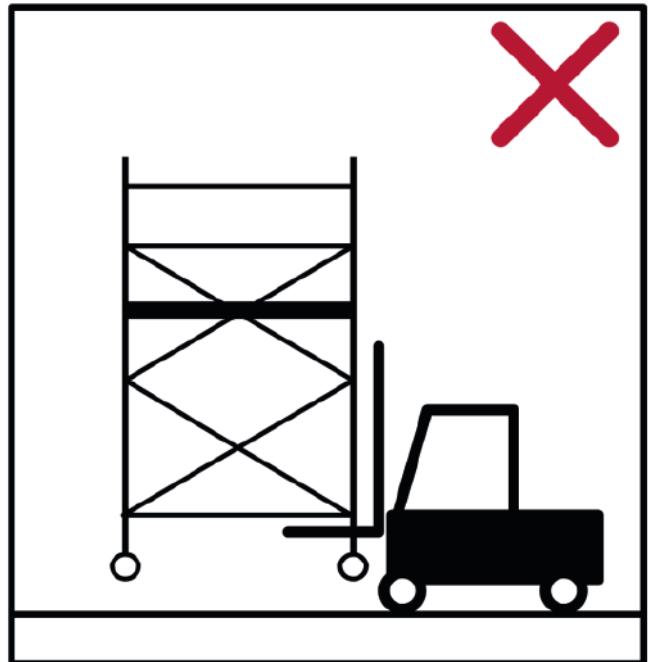
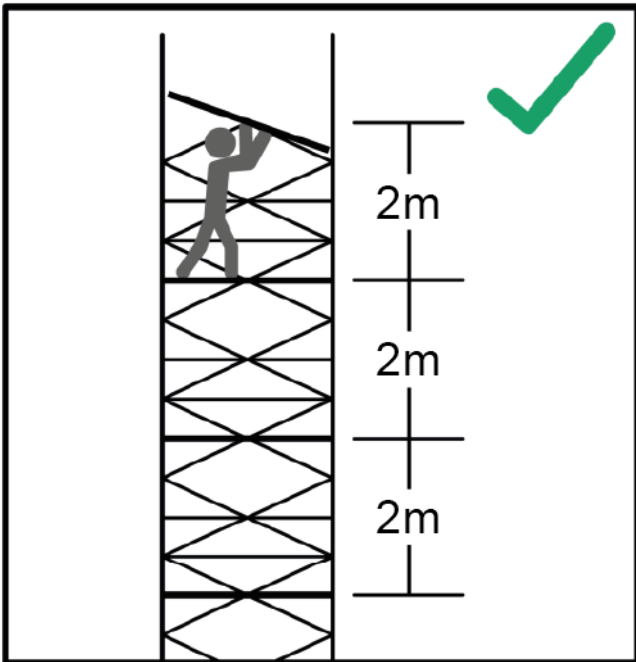

COMPONENT SCHEDULE

1.6m Long x 0.8m Wide (Single Width) MD Ladderspan Tower

SINGLE WIDTH MEDIUM DUTY SPAN TOWER TO BS EN 1004-1:2020

Using the 3T (Through The Trapdoor) assembly method

CODE		PLATFORM WORKING HEIGHT (m)																					
		INTERNAL & EXTERNAL USE										INTERNAL USE ONLY											
PART DESCRIPTION		Wt	2.2	2.7	3.2	3.7	4.2	4.7	5.2	5.7	6.2	6.7	7.2	7.7	8.2	8.7	9.2	9.7	10.2	10.7	11.2	11.7	12.2
2239	125mm Dia. Castor Wheel	2.5	4	4	4	4	4	4	4	4	4	4	4	4	4	4	4	4	4	4	4	4	4
3076	MD Adj. Alum Leg (black collar)	1.3	4	4	4	4	4	4	4	4	4	4	4	4	4	4	4	4	4	4	4	4	4
3036	MD 1.6m SW Toeboard	7.3	1	1	1	1	1	1	1	1	1	1	1	1	1	1	1	1	1	1	1	1	1
3008	MD SW 4 Rung Frame	6.5	1	1	2	1	2	2	3	2	3	4	3	4	4	4	5	4	5	5	6	5	6
3012	MD SW 4 Rung Ladder Frame	8.9	1	1	2	1	2	2	3	2	3	4	3	4	4	4	5	4	5	5	6	5	6
3010	MD SW 3 Rung Frame	5.0																					
3013	MD SW 3 Rung Ladder Frame	6.9																					
3011	MD SW 2 Rung Frame	3.6																					
3014	MD SW 2 Rung Ladder Frame	4.8																					
3015	MD 1.6m Horiz. Brace (blue)	2.0	6	8	10	10	10	12	14	14	14	16	18	18	18	20	22	22	22	24	26	26	26
3016	MD 1.6m Diag. Brace (green)	2.4	3	3	3	4	4	4	4	5	5	5	6	6	6	6	6	7	7	7	7	8	8
3021	MD 1.6m Trap Platform	12.5	1	2	2	2	2	2	3	3	3	3	4	4	4	4	5	5	5	5	6	6	6
3023	MD Small Stabiliser	4.7	4	4	4	4	4	4	4														
3024	MD Large Stabiliser	5.9								4	4	4	4	4	4	4	4	4	4	4	4	4	4
TOTAL SELF WEIGHT OF TOWER (kg)		97	117	125	132	136	143	163	176	179	187	207	214	218	225	246	253	257	264	285	292	295	
BUILD METHOD		A	B	C	D	A	B	C	D	A	B	C	D	A	B	C	D	A	B	C	D	A	

COMPONENT SCHEDULE

2.4m Long x 0.8m Wide (Single Width) MD Ladderspan Tower

SINGLE WIDTH MEDIUM DUTY SPAN TOWER TO BS EN 1004-1:2020

Using the 3T (Through The Trapdoor) assembly method

CODE		PLATFORM WORKING HEIGHT (m)																					
		INTERNAL & EXTERNAL USE										INTERNAL USE ONLY											
		Wt	2.2	2.7	3.2	3.7	4.2	4.7	5.2	5.7	6.2	6.7	7.2	7.7	8.2	8.7	9.2	9.7	10.2	10.7	11.2	11.7	12.2
2239	125mm Dia. Castor Wheel	2.5	4	4	4	4	4	4	4	4	4	4	4	4	4	4	4	4	4	4	4	4	4
3076	MD Adj. Alum Leg (black collar)	1.3	4	4	4	4	4	4	4	4	4	4	4	4	4	4	4	4	4	4	4	4	4
3037	MD 2.4m SW Toeboard	10.4	1	1	1	1	1	1	1	1	1	1	1	1	1	1	1	1	1	1	1	1	1
3008	MD SW 4 Rung Frame	6.5	1	1	2	1	2	3	2	3	3	4	3	4	4	5	4	5	5	5	6	5	6
3012	MD SW 4 Rung Ladder Frame	8.9	1	1	2	1	2	3	2	3	3	4	3	4	4	5	4	5	5	6	5	6	6
3010	MD SW 3 Rung Frame	5.0		1	1	1	1	1	1	1	1	1	1	1	1	1	1	1	1	1	1	1	1
3013	MD SW 3 Rung Ladder Frame	6.9		1	1	1	1	1	1	1	1	1	1	1	1	1	1	1	1	1	1	1	1
3011	MD SW 2 Rung Frame	3.6	1		1	1	1	1	1	1	1	1	1	1	1	1	1	1	1	1	1	1	1
3014	MD SW 2 Rung Ladder Frame	4.8	1		1	1	1	1	1	1	1	1	1	1	1	1	1	1	1	1	1	1	1
3017	MD 2.4m Horiz. Brace (yellow)	2.6	6	8	10	10	10	12	14	14	14	16	18	18	20	22	22	22	24	26	26	26	26
3018	MD 2.4m Diag. Brace (brown)	3.0	3	3	3	4	4	4	4	4	5	5	6	6	6	6	7	7	7	7	8	8	8
3022	MD 2.4m Trap Platform	18.2	1	2	2	2	2	2	3	3	3	3	4	4	4	5	5	5	5	6	6	6	6
3023	MD Small Stabiliser	4.7	4	4	4	4	4	4	4	4	4	4	4	4	4	4	4	4	4	4	4	4	4
3024	MD Large Stabiliser	5.9									4	4	4	4	4	4	4	4	4	4	4	4	4
TOTAL SELF WEIGHT OF TOWER (kg)		111	138	146	154	158	166	166	193	201	210	218	245	253	257	265	292	300	304	312	339	347	351
BUILD METHOD		A	B	C	D	A	B	C	C	D	A	B	C	D	A	B	C	D	A	B	C	D	A

ASSEMBLY INSTRUCTIONS - All Platform Working Heights

Step 1

Insert the leg & castor assembly into the base of the first main frame and ladder frame. When fully inserted, ensure the spring loaded pin is engaged into the hole in the side of the frames. Ensure all 4 wheels have the brakes applied.



Step 2

Connect 2 horizontal braces to the uprights of the first frame in the area below the bottom rung. Make sure that the braces are connected from the inside of the tower facing outwards. Make sure that the frame head fittings are pointing inwards into the tower.



Step 3

Connect the 2nd frame to the horizontal braces in the same position that they are located on the first frames. Make sure that the frame head fittings are pointing inwards into the tower.





Step 4

Connect 2 diagonal braces to the frames as shown. Keep the diagonal braces as close to the frame uprights as possible. Ensure that they run in opposite directions to each other.



Step 5

Install a trap platform on the 2nd rung up and 4 horizontal braces as guard rails. Using a spirit level, ensure that the framework is completely level by adjusting the legs. Twist the serrated collar above the wheel to adjust up & down.



Step 6

Once the framework is in position and level, connect 4 stabilisers to the corners. Fix the shorter arm to the lowest part of the frame, then connect the longer arm to the upper part, ensuring the foot is firmly placed on the ground. Small vertical adjustments can be made to either arm to guarantee a sturdy placement.

Build Method A 2.2m, 4.2m, 6.2m, 8.2m, 10.2m

Step 7.1

Working from the temporary platform, install a 2 rung main frame & a 2 rung ladder frame onto the 4 rung frames. Then, clip onto the top rung a diagonal brace. Diagonal braces always run parallel to the braces below.

Install another 4 guard rails above the 4 already in place for when the platform is relocated.



Step 7.2

Remove the lower 4 guardrails by using the 3T method or uninstalling them from the ground. Relocate the platform to the top rung of the first frames. If a 2.2m tower is being assembled, go straight to Step 10. From this new platform position, install a 4 rung frame and a 4 rung ladder frame. Clip on one standard diagonal brace on the same side of the tower as the one from step 7.1. The start position of the brace should be on the same rung height as the finishing position from the brace below - running in the same parallel direction.



Proceed to Step 9

Build Method B 2.7m, 4.7m, 6.7m, 8.7m, 10.7m



Step 7.1

Working from the temporary platform, install a 3 rung main frame & a 3 rung ladder frame onto the 4 rung frames. Then, clip onto the top rung a diagonal brace. Diagonal braces always run parallel to the braces below.



Step 7.2

Relocate the platform down one rung to the bottom rung of the first frames and add 2 additional guardrails. Working off this, install a 2nd platform 4 rungs above.



Step 7.3

Using the 3T method install 4 guardrails to the upper platform. If a 2.7m tower is being assembled, go straight to step 10. The platform on the bottom rung of the tower and the 4 guardrails can now be removed. Make sure that there are still 2 horizontal braces on the bottom rung and the 4th rung up on the tower.

Proceed to Step 8

Build Method C 3.2m, 5.2m, 7.2m, 9.2m

Step 7.1

Working from the temporary platform, install a 4 rung main frame & a 4 rung ladder frame onto the first set of 4 rung frames. Then, clip 1 diagonal brace on. The top of the brace connects to the 2nd rung down on the new frame. The bottom of the brace connects to the 2nd rung down on the original frame. The brace is to run in the same parallel direction as the diagonal brace below it.



Step 7.2

Install a 2nd platform 4 rungs above the first platform. Using the 3T method install 4 guardrails to the upper platform. If a 3.2m tower is being assembled, go to step 10.

Proceed to Step 8



Build Method D 3.7m, 5.7m, 7.7m, 9.7m



Step 7.1

Working from the temporary platform, install a 2 rung main frame & a 2 rung ladder frame onto the 4 rung frames. Then, clip onto the top rung of one frame a diagonal brace. The other end connects to the rung 3 below on the opposite face.

Install another 4 guard rails above the 4 already in place for when the platform is relocated.



Step 7.2

Remove the lower 4 guardrails by either using the 3T method or uninstalling them from the ground. Then relocate the platform to the top rung of the first frames. Working off this new platform position, install a 3 rung main frame and a 3 rung ladder frame. Then clip 1 more diagonal brace.



Step 7.3

Lower the platform down 1 rung and relocate the guardrails into the correct positions using the 3T method. Install another platform 4 rungs above and install 4 guardrails using the 3T method. If a 3.7m tower is being assembled, go to step 10.

Proceed to Step 8

All Platform Working Heights

Step 8

Working from the top platform, install a 4 rung main frame & ladder frame. Clip 1 diagonal brace onto the same side as the previously installed diagonal brace. The top of the brace connects to the 2nd rung down on the new frame. The bottom of the brace connects to the 2nd rung down on the original frame - running in the same parallel direction as the diagonal brace below.

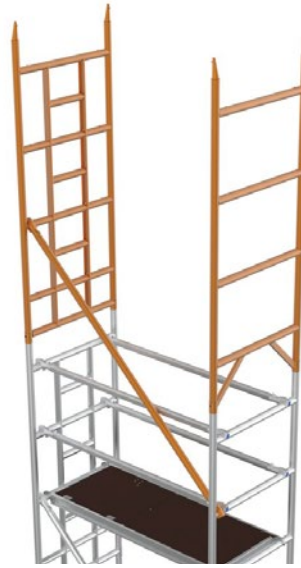

Step 9

Install a trap platform 4 rungs above the previous platform. Using the 3T method install 4 guardrails to the upper platform.

Now, repeat steps 8 and 9 until the required platform working height is achieved. Once the final step 9 is complete, move to step 10.



Step 10

Finally, working from the guard railed platform, install a toeboard, ensuring that the sides are hooked securely over the outside edge of both platforms.



DISMANTLING INSTRUCTIONS - All Platform Working Heights



Step 1

The dismantling procedure requires a minimum of 2 operatives to complete the task safely. To start, first remove the aluminium toeboard assembly.



Step 2

Now, relocate the uppermost diagonal brace downwards so the top hook is located on the same rung as the uppermost platform. This can be done by either using one operative on the top platform and one operative on the platform underneath, or by disengaging the top hook then climbing down onto the platform below and disengage the 2nd hook.



Step 3

Next, remove the 4 guardrails. To remove braces or guardrails, first disconnect each brace at the end furthest away from the platform trap door. Then immediately take up the protected position detailed in the 3T method. Whilst standing through the trapdoor as per the 3T method, disconnect the braces completely.

DISMANTLING INSTRUCTIONS - All Platform Working Heights

Step 4

Now, working from the platform below, the upper platform can be removed. Once this is fully removed, the recently relocated diagonal brace(s) can now be taken off. This can be done by one operative from the platform.



Step 5

Now remove the final 2 frames off the top of the tower.

Now repeat steps 2 to 5 until the tower is dismantled or the new platform height is achieved.



Components



2239 125mm castor wheel
3076 MD Adj. Leg



3008 MD S/W 4 Rung Frame



3012 MD S/W 4 Rung Ladder Frame



3010 MD S/W 3 Rung Frame



3013 MD S/W 3 Rung Ladder Frame



3011 MD S/W 2 Rung Frame

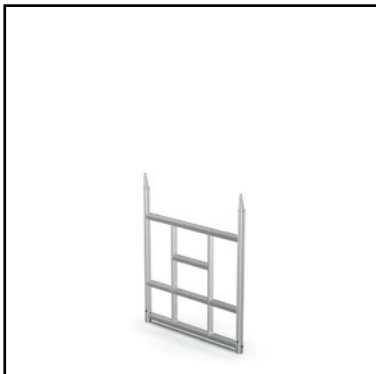

3014 MD S/W 2 Rung Ladder Frame



3015 1.6m Horiz. Brace (blue)
3017 2.4m Horiz. Brace (yellow)



3016 1.6m Diag. Brace (green)
3018 2.4m Diag. Brace (brown)



3023 MD Small Stabiliser
3024 MD Large Stabiliser



3021 1.6m Trap Platform
3022 2.4m Trap Platform



3036 1.6m S/W Toeboard
3037 2.4m S/W Toeboard

THE HEIGHT OF SAFETY

For more information regarding our range of access products and services, please get in touch with us:

Lakeside Industries Ltd

Unit 19 Howard Road, Park Farm Industrial Estate
Redditch, Worcestershire. B98 7SE. UK

t: +44(0)1527 500 577

e: sales@altoaccess.com

w: www.altoaccess.com

 @lakesideindust

 @altotowers

 lakeside-industries-ltd



Manufacturing Member

Lakeside Industries Ltd

Unit 19 Howard Road, Park Farm Industrial Estate, Redditch, Worcestershire. B98 7SE
+44(0)1527 500577 | sales@altoaccess.com | www.altoaccess.com

