

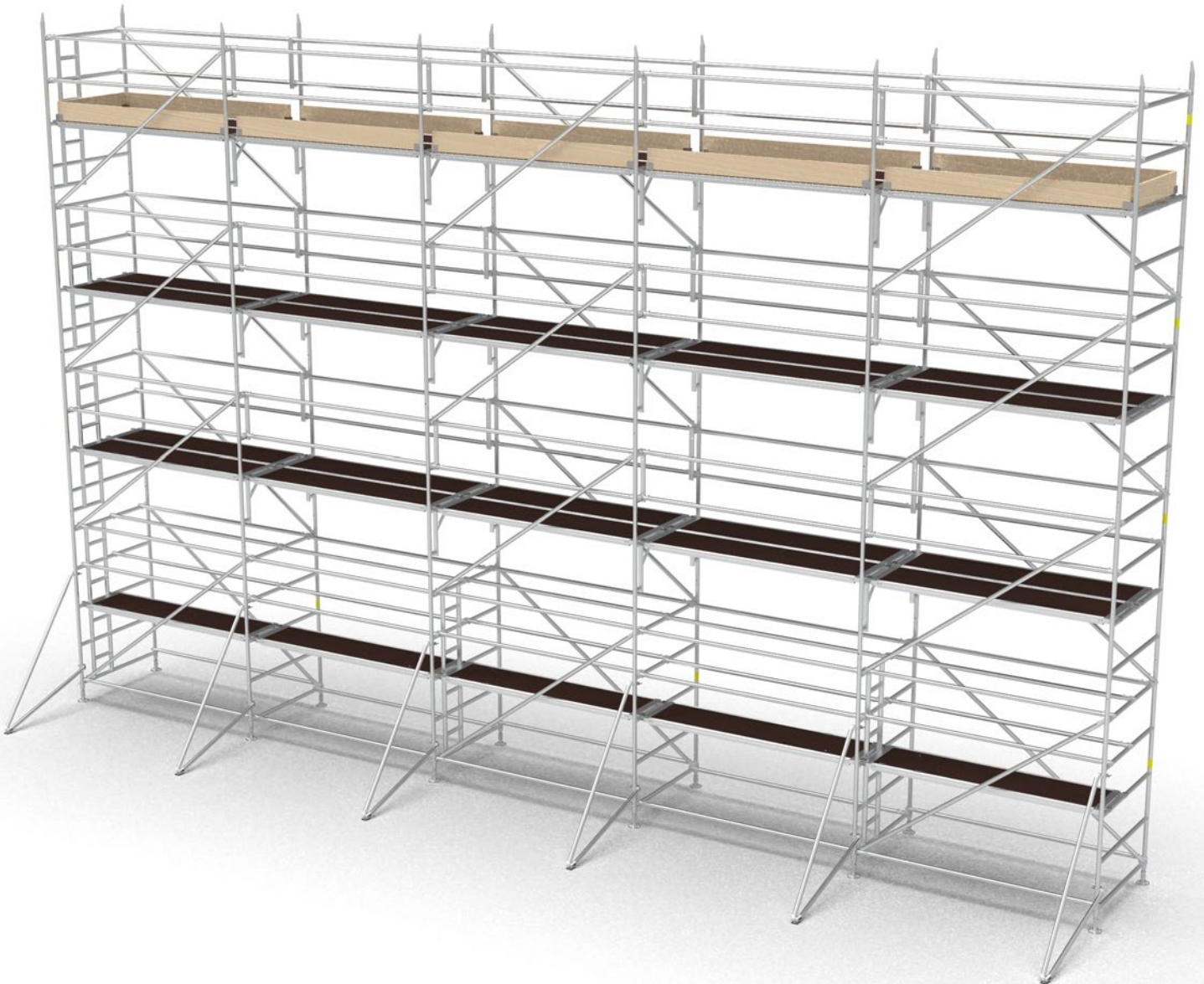

Instruction Manual BS EN 1004-2:2021
The ALTO HD Linked Towers are certified to BS 1139-6:2022

3T - Through The Trapdoor Method

Assembly guide using 5 Rung Starter Frames & Stabilisers



Introduction

Please read these instructions carefully and ensure that you fully understand all of the information contained herein. All of the information in this document is vital for the safe utilisation of your Alto Heavy Duty Tower in freestanding Linked Tower applications.

These instructions only cover the assembly of this configuration of equipment, which is designed primarily for construction and maintenance tasks in a fixed position over a large area at platform heights of between 3m and 8m. All Alto Access products are professional quality engineered equipment designed primarily with safety in mind and meet or exceed all standards, recommendations and guidelines. Used properly, Alto access equipment will keep you safe when working at height.

This manual contains all of the information necessary to correctly assemble your Alto Heavy Duty mobile access tower equipment for this application in accordance with BS 1139-6:2022 and incorporates all of the requirements of the PASMA 3T method of assembly as endorsed by the HSE.

This manual should be used in conjunction with your Risk Assessment and Method Statement and in line with the Work at Height Regulations 2005 which place an obligation on employers to eliminate or minimise risks. This manual must be made available to the user/assembler at all pertinent times.

A Risk Assessment and Method Statement must be undertaken before installation commences and should include the relevant stabilisation to be applied to the specific structure being built in line with the guidance contained in this manual.

Only competent and qualified personnel should undertake erection, dismantling or alteration, organisation, planning or supervision of mobile access towers. In the case of any doubt, sufficient relevant additional training must be given beforehand to ensure safe use. For further information on the use of mobile access towers consult PASMA (www.pasma.co.uk; Tel +44 (0) 345 2 30 4041).

For any additional technical information or specific advice please contact the manufacturer Lakeside Industries Limited Tel: +44 1527 500577 or Email: sales@altoaccess.com.

Certifications

The Alto Heavy Duty Tower is a mobile access tower certified to BS EN 1004-1:2020 Class 3. These instructions cover applications outside the scope of BS EN 1004-1:2020, within the scope of BS 1139-6:2022 to ensure that the configuration of the equipment meets the relevant requirements. This tower is manufactured in our ISO 9001 accredited facility. This manual complies with BS EN 1004-2:2021.

Maximum Safe Working Loads

The safe working load of each bay of the tower is 1,500 kg including its own weight as it is to be assembled on base jacks. The maximum leg load imposed by the tower on its supporting surface is 750 kg when loaded to its maximum safe working load. The tower is a Class 3 tower.

The maximum safe working load of any individual platform unit within the tower is 324 kg evenly distributed.

The maximum safe uniformly distributed working load which may be placed on the working platform of the tower is 1,500 kg per bay over all the working platforms in use.

The maximum number of working platforms allowed in this configuration is set out in the table below:

| LOADING CLASS | PLATFORM LENGTH | No. OF WORKING PLATFORMS |
|----------------------------|-----------------|--------------------------|
| 3 (2.0 kn/m ²) | 1.8m long | 1 |
| 2 (1.5 kn/m ²) | 1.8m long | 2 |
| 3 (2.0 kn/m ²) | 2.7m long | 1 |
| 2 (1.5 kn/m ²) | 2.7m long | 2 |

The maximum number of operatives permitted on the tower during use is 12.

The maximum number of operatives permitted on the tower during assembly and dismantling is 8.

The maximum number of operatives permitted on any one platform unit is 2.

The maximum number of people on a working platform level permitted to simultaneously exert a horizontal load of 0.3 kN is 1 per bay.

If higher loadings are required, contact your supplier or the manufacturer - Lakeside Industries Limited, for advice. Tel: +44 1527 500577 or Email: sales@altoaccess.com.

Inspection Care & Maintenance

Alto Access equipment is designed and manufactured to the highest standards in the industry and is stronger, more robust and safer than any comparable competitor product. Properly cared for, it will give a long and productive service life.

Inspection and maintenance guidance is published by the manufacturer for Alto HD equipment. This may be found here: www.altoaccess.com/assets/inspection_hd.pdf

ALTO HD Tower System equipment should not be modified in any way and should only be repaired by

the manufacturer - Lakeside Industries Ltd - or by authorised agents. If it is suspected that equipment has been damaged, modified or repaired by any other provider, the equipment should be quarantined and returned to Lakeside Industries Ltd for free inspection. No liability will be accepted in relation to equipment that has been subjected to unauthorised modification or repair.

ALTO HD Tower System equipment is a robust product designed to operate in the construction industry environment. However, misuse or mishandling (including dropping or overloading or otherwise incorrectly using components) risks impairing the structural integrity of the components.

Components should be handled with care and stacked and secured safely whilst in transit.

Never use any equipment which is damaged, has parts missing or is improperly assembled.

Safety

- This information shall be available at the location of use of the prefabricated tower scaffold.
- This prefabricated tower scaffold shall only be used according to this information.
- A risk assessment and method statement must be prepared sufficient to ensure the safe assembly, use and dismantling of a freestanding linked tower structure and the elimination or minimisation of all consequent risks.
- Check that all of the necessary components, tools and equipment for the particular tower configuration to be built are on site, undamaged and functioning correctly. Damaged/incorrect components must not be used.
- BS 1139-6:2022 tower applications may only be used with 3T Alto towers. BS 1139-6:2022 tower applications may not be created using Advance Guard Rail (AGR) towers.
- This is a static tower. These instructions only cover the assembly of this specific structure on base jacks. If a mobile tower structure is required, contact the manufacturer Lakeside Industries Limited for advice Tel: +44 1527 500577 or Email: sales@altoaccess.com. This tower is not to be moved when built.
- Check that the surface on which the tower is to be located is capable of supporting the tower and its payload. Check that the level and slope of the ground do not render the location unsafe for the purposes of assembling, using and dismantling the tower.
- Beware obstructions when assembling, altering and dismantling the tower.
- When working outdoors, the weather forecast shall be taken into account before assembly, use and dismantling.
- Platforms must be installed with vertical distances between them not exceeding 2.1m when assembling and dismantling.

- Towers must always be climbed from the inside using the built in ladders (or Alto stair units if applicable). If the work carried out from the tower requires frequent carrying of equipment and materials up or down the tower, an Alto stair tower should be used in preference to a ladderspan tower.
- The tower must be levelled when erected using the adjustable jack legs.
- Four or more persons are required for the safe erection and dismantling of this tower.
- Always comply with the Work at Height Regulations 2005 when erecting, dismantling & using the tower.
- When lifting components, tools or materials, always use reliable lifting equipment and fastening methods and always lift from within the footprint of the tower structure to prevent risk of the tower overturning.
- Users must be aware of the effects of horizontal and vertical loads on the structure when using the tower which may impair the stability of the tower. Examples would be loads resulting from work on an adjacent structure or wind loads which may be increased by tunnelling effects around adjacent buildings.
- Beware live electrical installations, cables, moving machinery or other obstructions when erecting, dismantling or using the tower. The tower is a conductive metallic structure.
- Do not use boxes, ladders or other items to gain additional height.
- Do not stand on guard rails for any reason.
- If the tower is to be used in connection with hoisting arrangements, this requires specific advice from the manufacturer to ensure safety. Contact the manufacturer Lakeside Industries Limited for advice on loadings Tel: +44 1527 500577 or Email: sales@altoaccess.com.
- Prefabricated tower scaffolds in accordance with this standard are not designed to be lifted or suspended.
- When fitting platforms always engage wind latches.
- Fit guard rails to all Platforms.
- Fit toe boards to all Working Platforms.
- Every erected tower must be inspected at least every seven days and any tower which has been left unattended should be inspected before use to ensure that:
 1. No components have been removed or relocated incorrectly;
 2. The tower is still vertical; and
 3. No environmental or other factors have arisen which will influence safe use of the tower.
 4. the applied stabilisation methods and devices are still correctly positioned and operating effectively.
- Alto Access Products recommends the use of the PASMA TowerSure inspection system. For more information, please visit: pasma.co.uk/towersure.

- This tower is not to be sheeted.
- Alterations to the prefabricated tower are only permitted where they are shown in these instructions.
- User training courses cannot be a substitute for instruction manuals and assembly, use and dismantling plans but can only complement them.
- Only the components specified in this information shall be used.
- Damaged or incorrect components shall not be used.
- Prefabricated tower scaffolds designed in accordance with this standard are not anchor points for personal fall arrest equipment.
- Working is only permitted on a platform with a complete side protection including guardrails and toeboards.
- In the event that an alteration to the prefabricated tower scaffold design is required, approval from the supplier and/or designer shall be obtained and a revised instruction manual or assembly, user and dismantling plan created.
- When a prefabricated scaffold tower is used as a means of access to another place it shall:
 - » Be built on base plates
 - » Be tied in to the adjacent structure with ties of sufficient number and capacity to cope with a horizontal load of 10% of the maximum UDL of the working platform i.e. 2 kN.
 - » Be positioned so that any horizontal gap between the platform of the prefabricated scaffold tower and the place being accessed is no greater than 25 mm; and
 - » Be positioned so that the upper surface of the platform and surface which is being accessed are vertically aligned within a tolerance of ± 25 mm.
 - » Means of protection shall be removed only for the time and to the extent necessary to gain access or egress or for the performance of a particular task and shall be replaced as soon as practicable.
 - » Attention is drawn to the Work at Height Regulations 2005 Schedule 1, Schedule 2 Regulation 5 and Schedule 3 Part 1 Regulation 5.
 - » Provision shall be made to prevent falls – not only from the prefabricated tower scaffold, but also from the adjacent structure.
 - » The safety of persons once they have transferred to the adjacent place shall be taken into account as this now becomes a place of work at height.
 - » The strength of the adjacent place shall be assessed to verify that it is safe to step on to (e.g. not a fragile surface) and is a suitable and a safe place for work with adequate collective protection or other fall prevention measures.

- » A prefabricated tower scaffold shall not be used as an anchor point for personal fall protection or work positioning equipment. They are not designed for this purpose even when tied to a supporting structure.
- » A prefabricated tower scaffold shall not be used as a means or element of edge protection. They are not designed or suitable for this purpose even when tied to a supporting structure. Edge protection shall be designed and installed in accordance with BS EN 13374.

Wind Speeds

The weather forecast must be taken into account before assembly, use and dismantling. Persons using or responsible for towers must beware of the effect of wind on the structure. Wherever possible, as a precaution, it is advisable to tie the tower in to a rigid structure if it is to be used where it is exposed to potential windy conditions. Users should beware the potential tunnelling effect of open ended or unclad buildings and narrow openings between buildings. We recommend that the use of the tower is discontinued in conditions where the wind speed is above 17mph (force 4).

| WIND DESCRIPTION | BEAUFORT SCALE | AVERAGE SPEED | INFORMATION |
|------------------|----------------|---------------|---|
| Medium Breeze | 4 | 13-17 mph | Safe to work on tower. |
| Strong Breeze | 6 | 25-31 mph | Tie the tower to a solid structure. Do not work on tower. |
| Gale Force | 8 | 39-46 mph | Towers must be dismantled. Towers must not be assembled. |

Tying In

If the tower is to be tied in, the following information is relevant:

- This prefabricated tower scaffold has been designed to be properly secured to a suitable adjacent supporting structure capable of withstanding the forces that will be imposed upon it by the attachment of the tower. Devices for securing the tower must be simultaneously rigid in both tension and compression and capable of withstanding and transmitting the loads imposed by the tower to the supporting structure.
- When used, select and install anchors in concrete and masonry must be selected and installed in accordance with BS 8539.
- Scaffold couplers and tubes used for tying in must comply with BS EN 74-1:2005 and BS EN 12811-2:2004 respectively.
- For more information on stabilisation by tying in, see separate guidance documentation issued by the manufacturer.

- If ballast is necessary, it must be secured in position and made of rigid materials such as steel or concrete, but excluding liquids or granular materials.
- If users consider that ballast may be necessary, contact the manufacturer Lakeside Industries Limited for advice on quantities and locations. Tel: +44 1527 500577 or Email: sales@altoaccess.com.

Erecting & Dismantling the Tower

All BS 1139-6:2022 tower structures using Alto HD equipment must be built and dismantled in accordance with the step by step instructions set out below and having regard to the working at height regulations and Health & Safety legislation.

3T Method Explained

The “3T” or “through the trapdoor” method is one of the two permitted ways of assembling a tower without the assembler being at risk of falling. This tower is a 3T tower.

Step 1:

As each new level of platform is installed, the operative takes up a working position in the trap door of the platform, standing on the ladder and leaning back against the edge of the trapdoor aperture.

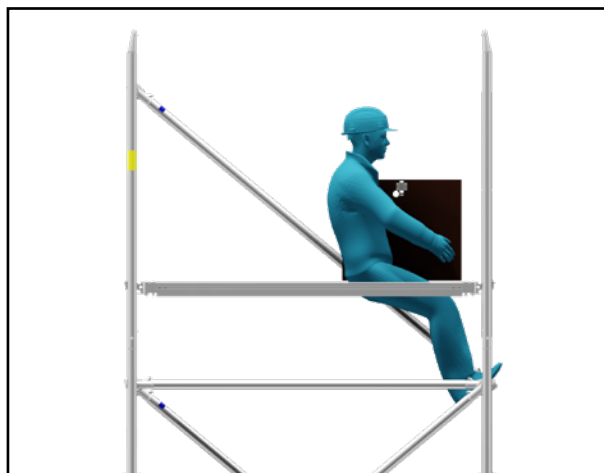

Step 2:

From this position the operative fits the horizontal braces 500mm and 1000 mm above the platform level (i.e. on the first and second available rungs). If the far end of the guardrail braces don't fully engage when they are put in place, the operative fully engages it when first climbing up onto the platform. This process ensures that operatives never have to stand on an unguarded platform.

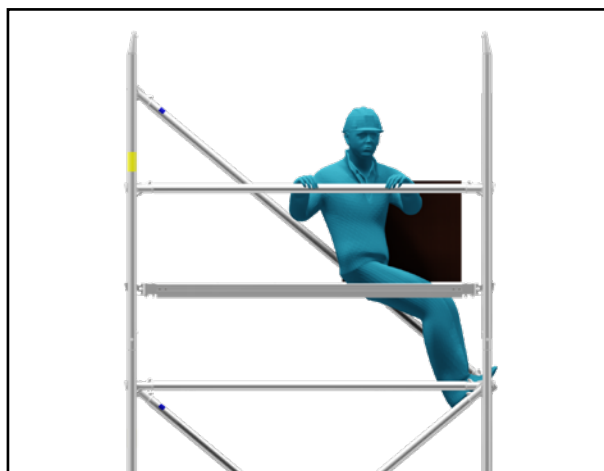

Frames

Almost all linked tower structures compromise alternating “tower” and “bridge” sections. In Alto structures “odd” number bays are generally tower sections.

It is important to understand which bays are towers and which are bridges for the following reason.

Frames must always be assembled with the offset conical head pointing inwards on “tower” bays.



Braces

All braces are fitted with spring loaded pins that automatically lock the brace into position when attached to a tower. Brace hooks **must** be located either over the rung screw heads, between 2 screw heads or between the frame upright and a screw head to prevent lateral movement.

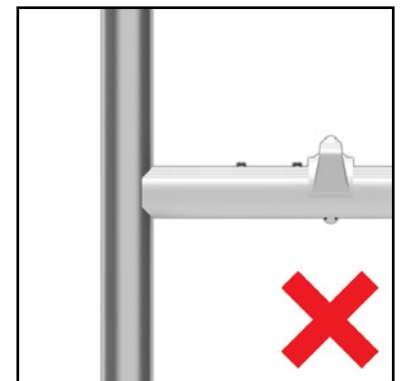
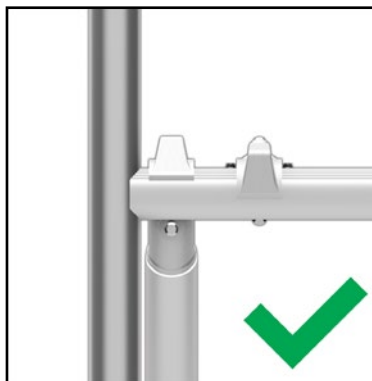

Diagonal braces **must** always be located with the claw opening facing down. Horizontal braces must be located with the claw facing either down (on the rung) or outwards (if on the upright).

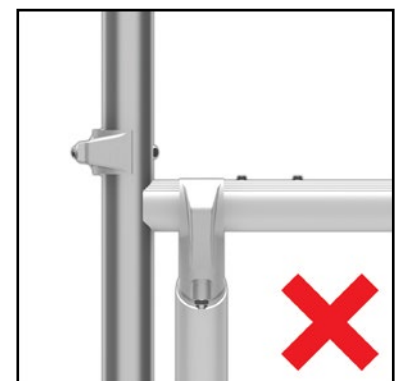
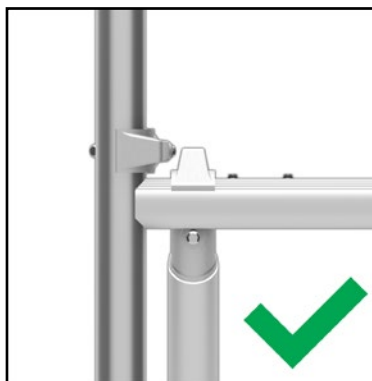

Stabilisation

Stabilisers should always be attached to the linked tower structure so as to maximise the width of the tower structure. Set the stabilisers so they project out perpendicularly to the long side of the linked tower structure. The correct size stabilisers must always be used – see component schedule for details. As this manual only covers linked towers built as free-standing structures using standard stabilisers and linked towers are presumed to be only typically used outdoors, this manual is limited to maximum platform heights of 8 metres or less.

ADDITIONAL STABILISATION

This manual covers linked towers which are built as free-standing structures using standard stabilisers. The effectiveness of stabilisers is, by definition a function of the increase in base size which they create and their strength in compression. Where additional stability is required for any reason, it may be possible to supplement the stabilisers by utilising one or more of the following:

- a compliant pattern of tying in using appropriate materials and anchors
- additional stub bracing set against adjacent immovable structures
- larger stabilisers created using scaffold tube and standard couplers
- buttress towers

These solutions are outside the scope of standard linked freestanding tower builds and users must contact the manufacturer Lakeside Industries Limited for advice on possible alternative solutions. Tel: +44 1527 500577 or Email: sales@altoaccess.com.

Unattended Towers

To prevent use by unauthorised persons of complete or incomplete towers when unattended, steps should be taken to prevent unauthorised access. Appropriate steps may include some or all of the following:

- Use of scaffold alarms.
- Suitable physical means such as barriers or site fencing to prevent access to the area immediately around the tower.
- Warning signs identifying the areas where access is not permitted should be displayed at the access points to area occupied by the tower.
- Attaching a well designed and correctly fitted ladder guard to the lowest levels of the tower.
- Appropriate site security.
- Towers which have been left unattended should be inspected before use as outlined on page 5 above.

Signage

After assembly or alteration, the following minimum information shall be displayed on the prefabricated tower scaffold and be clearly visible from the ground (e.g. on a tag):

- The name and contact details of the responsible person.
- If the tower is ready for application or not.
- The load class and the uniformly distributed load.
- If the prefabricated tower scaffold is intended for indoors use only.
- The date of assembly.
- The maximum number of simultaneous working platforms permitted.
- The maximum number of persons permitted on the working platform(s) during use.
- The maximum number of persons permitted on the tower during assembly and dismantling.
- The maximum number of persons permitted on any one platform.
- The maximum safe working load on working platforms.
- The maximum safe working load on the prefabricated tower scaffold.
- The load class of the prefabricated tower scaffold.
- The maximum horizontal force permitted at the working platform(s).
- The maximum wind limits for working on the prefabricated tower scaffold.
- The maximum wind limits for the prefabricated tower scaffold.

Component Schedule

Double width linked tower assembly using 1.8m towers & 2.7m link decks

Build Method 'A'

This schedule shows the parts required for each bay of linked tower structures for the heights shown assuming that access is required at one end of the structure only. Each structure is defined as a starter tower with any number of additional bays. Counting from the starter tower as "1", bays will either be even or odd numbers. The end bay will always be an odd number and the relevant part changes are shown to produce the correct end configuration. Parts table assumes one working level. For additional working levels, add toeboards and corner clips based on table quantities.

| CODE | PART DESCRIPTION | Wt | 4.4m Platform Height | | | | 6.4m Platform Height | | | | 8.4m Platform Height | | | |
|------|---------------------------------------|------|----------------------|----------|---------|---------|----------------------|----------|---------|---------|----------------------|----------|---------|---------|
| | | | Start Tower | Even Bay | Odd Bay | End Bay | Start Tower | Even Bay | Odd Bay | End Bay | Start Tower | Even Bay | Odd Bay | End Bay |
| 2233 | HD Adj. Swivel Base Jack | 2.2 | 4 | | 4 | | 4 | | 4 | | 4 | | 4 | |
| 2001 | HD 1.4m Base Frame | 12.9 | 1 | | 1 | | 1 | | 1 | | 1 | | 1 | |
| 2212 | HD 1.4m 5 Rung Ladder Frame | 14.7 | 1 | | 1 | | 1 | | 1 | | 1 | | 1 | |
| 2002 | HD 1.4m Main Frame | 10.9 | | | | 1 | | | | 2 | | | | 3 |
| 2213 | HD 1.4m 4 Rung Ladder Frame | 12.9 | 1 | | | | 2 | | | | 3 | | | |
| 2008 | HD 1.4m 1/2 Frame | 5.6 | 1 | | 1 | | 1 | | 1 | | 1 | | 1 | |
| 2215 | HD 1.4m 2 Rung Ladder Frame | 6.6 | 1 | | 1 | | 1 | | 1 | | 1 | | 1 | |
| 2009 | HD 1.4m Walkthru' "H" Frame | 10.3 | 1 | | 2 | -1 | 2 | | 4 | -2 | 3 | | 6 | -3 |
| 2010 | HD 1.4m Walkthru' Frame Gate | 3.8 | 1 | | 2 | -1 | 2 | | 4 | -2 | 3 | | 6 | -3 |
| 2040 | HD 1.8m Brace | 2.6 | 12 | | 12 | | 16 | | 16 | | 20 | | 20 | |
| 2041 | HD 2.7m Brace | 3.6 | 4 | 12 | 4 | | 6 | 16 | 6 | | 8 | 20 | 8 | |
| 2080 | HD 1.8m x 3 Rung Brace (Blue) | 3.3 | 2 | | 2 | | 2 | | 2 | | 2 | | 2 | |
| 2043 | HD 1.8m Platform | 14.4 | 1 | | 2 | | 2 | | 4 | | 3 | | 6 | |
| 2201 | HD 1.8m Trap Platform | 14.8 | 2 | | 1 | | 3 | | 1 | | 4 | | 1 | |
| 2044 | HD 2.7m Platform | 20.4 | | 2 | | | | 4 | | | | 6 | | |
| 2202 | HD 2.7m Trap Platform | 20.8 | | 1 | | | | 1 | | | | 1 | | |
| 2071 | HD D/W Timber Toeboard End | 5.2 | 1 | | | 1 | 1 | | | 1 | 1 | | | 1 |
| 2069 | HD 1.8m Timber Toeboard Side | 7.3 | 2 | | | | 2 | | | | 2 | | | |
| 2086 | HD 1.8m Timber Toeboard Side - Linked | 8.0 | | | 2 | | | | 2 | | | | 2 | |
| 2087 | HD 2.7m Timber Toeboard Side - Linked | 12.0 | | 2 | | | | 2 | | | | 2 | | |
| 2074 | HD Toeboard Corner Bracket | 0.9 | 2 | | | 2 | 2 | | | 2 | 2 | | | 2 |
| 2079 | HD Toeboard Inline Bracket | 0.8 | 2 | 2 | 2 | -2 | 2 | 2 | 2 | -2 | 2 | 2 | 2 | -2 |
| 2056 | HD Small Stabiliser | 5.9 | 4 | | 4 | | 4 | | 4 | | | | | |
| 2057 | HD Large Stabiliser | 7.6 | | | | | | | | | 4 | | 4 | |

| | | | | | | | | | | | | |
|----------------------------------|-----|-----|-----|---|-----|-----|-----|----|-----|-----|-----|----|
| TOTAL SELF WEIGHT OF TOWER (KGS) | 219 | 131 | 214 | 2 | 293 | 186 | 289 | -1 | 374 | 241 | 371 | -5 |
|----------------------------------|-----|-----|-----|---|-----|-----|-----|----|-----|-----|-----|----|

Component Schedule

Double width linked tower assembly using 1.8m towers & 2.7m link decks

Build Method 'B'

This schedule shows the parts required for each bay of linked tower structures for the heights shown assuming that access is required at one end of the structure only. Each structure is defined as a starter tower with any number of additional bays. Counting from the starter tower as "1", bays will either be even or odd numbers. The end bay will always be an odd number and the relevant part changes are shown to produce the correct end configuration. Parts table assumes one working level. For additional working levels, add toeboards and corner clips based on table quantities.

| CODE | PART DESCRIPTION | Wt | 4.9m Platform Height | | | | 6.9m Platform Height | | | |
|----------------------------------|---------------------------------------|------|----------------------|----------|---------|---------|----------------------|----------|---------|---------|
| | | | Start Tower | Even Bay | Odd Bay | End Bay | Start Tower | Even Bay | Odd Bay | End Bay |
| 2233 | HD Adj. Swivel Base Jack | 2.2 | 4 | | 4 | | 4 | | 4 | |
| 2001 | HD 1.4m Base Frame | 12.9 | 1 | | 1 | | 1 | | 1 | |
| 2212 | HD 1.4m 5 Rung Ladder Frame | 14.7 | 1 | | 1 | | 1 | | 1 | |
| 2002 | HD 1.4m Main Frame | 10.9 | | | | 1 | | | | 2 |
| 2213 | HD 1.4m 4 Rung Ladder Frame | 12.9 | 1 | | | | 2 | | | |
| 2006 | HD 1.4m 3/4 Frame | 8.2 | 1 | | 1 | | 1 | | 1 | |
| 2214 | HD 1.4m 3 Rung Ladder Frame | 9.8 | 1 | | 1 | | 1 | | 1 | |
| 2009 | HD 1.4m Walkthru' "H" Frame | 10.3 | 1 | | 2 | -1 | 2 | | 4 | -2 |
| 2010 | HD 1.4m Walkthru' Frame Gate | 3.8 | 1 | | 2 | -1 | 2 | | 4 | -2 |
| 2040 | HD 1.8m Brace | 2.6 | 13 | | 13 | | 17 | | 17 | |
| 2041 | HD 2.7m Brace | 3.6 | 4 | 13 | 4 | | 6 | 17 | 6 | |
| 2080 | HD 1.8m x 3 Rung Brace (Blue) | 3.3 | 2 | | 2 | | 2 | | 2 | |
| 2043 | HD 1.8m Platform | 14.4 | 1 | | 2 | | 2 | | 4 | |
| 2201 | HD 1.8m Trap Platform | 14.8 | 2 | | 1 | | 3 | | 1 | |
| 2044 | HD 2.7m Platform | 20.4 | | 2 | | | | 4 | | |
| 2202 | HD 2.7m Trap Platform | 20.8 | | 1 | | | | 1 | | |
| 2071 | HD D/W Timber Toeboard End | 5.2 | 1 | | | 1 | 1 | | | 1 |
| 2069 | HD 1.8m Timber Toeboard Side | 7.3 | 2 | | | | 2 | | | |
| 2086 | HD 1.8m Timber Toeboard Side - Linked | 8.0 | | | 2 | | | | 2 | |
| 2087 | HD 2.7m Timber Toeboard Side - Linked | 12.0 | | 2 | | | | 2 | | |
| 2074 | HD Toeboard Corner Bracket | 0.9 | 2 | | | 2 | 2 | | | 2 |
| 2079 | HD Toeboard Inline Bracket | 0.8 | 2 | 2 | 2 | -2 | 2 | 2 | 2 | -2 |
| 2056 | HD Small Stabiliser | 5.9 | 4 | | 4 | | 4 | | 4 | |
| TOTAL SELF WEIGHT OF TOWER (KGS) | | | 227 | 134 | 222 | 2 | 301 | 190 | 297 | -1 |

Component Schedule

Double width linked tower assembly using 1.8m towers & 2.7m link decks

Build Method 'C'

This schedule shows the parts required for each bay of linked tower structures for the heights shown assuming that access is required at one end of the structure only. Each structure is defined as a starter tower with any number of additional bays. Counting from the starter tower as "1", bays will either be even or odd numbers. The end bay will always be an odd number and the relevant part changes are shown to produce the correct end configuration. Parts table assumes one working level. For additional working levels, add toeboards and corner clips based on table quantities.

| CODE | PART DESCRIPTION | Wt | 5.9m Platform Height | | | | 7.9m Platform Height | | | |
|----------------------------------|---------------------------------------|------|----------------------|----------|---------|---------|----------------------|----------|---------|---------|
| | | | Start Tower | Even Bay | Odd Bay | End Bay | Start Tower | Even Bay | Odd Bay | End Bay |
| 2233 | HD Adj. Swivel Base Jack | 2.2 | 4 | | 4 | | 4 | | 4 | |
| 2001 | HD 1.4m Base Frame | 12.9 | 1 | | 1 | | 1 | | 1 | |
| 2212 | HD 1.4m 5 Rung Ladder Frame | 14.7 | 1 | | 1 | | 1 | | 1 | |
| 2002 | HD 1.4m Main Frame | 10.9 | | | | 1 | | | | 2 |
| 2213 | HD 1.4m 4 Rung Ladder Frame | 12.9 | 1 | | | | 2 | | | |
| 2006 | HD 1.4m 3/4 Frame | 8.2 | 1 | | 1 | | 1 | | 1 | |
| 2214 | HD 1.4m 3 Rung Ladder Frame | 9.8 | 1 | | 1 | | 1 | | 1 | |
| 2008 | HD 1.4m 1/2 Frame | 5.6 | 1 | | 1 | | 1 | | 1 | |
| 2215 | HD 1.4m 2 Rung Ladder Frame | 6.6 | 1 | | 1 | | 1 | | 1 | |
| 2009 | HD 1.4m Walkthru' "H" Frame | 10.3 | 1 | | 2 | -1 | 2 | | 4 | -2 |
| 2010 | HD 1.4m Walkthru' Frame Gate | 3.8 | 1 | | 2 | -1 | 2 | | 4 | -2 |
| 2040 | HD 1.8m Brace | 2.6 | 18 | | 18 | | 22 | | 22 | |
| 2041 | HD 2.7m Brace | 3.6 | 4 | 18 | 4 | | 6 | 22 | 6 | |
| 2080 | HD 1.8m x 3 Rung Brace (Blue) | 3.3 | 4 | | 4 | | 4 | | 4 | |
| 2043 | HD 1.8m Platform | 14.4 | 1 | | 2 | | 2 | | 4 | |
| 2201 | HD 1.8m Trap Platform | 14.8 | 3 | | 2 | | 4 | | 2 | |
| 2044 | HD 2.7m Platform | 20.4 | | 2 | | | | 4 | | |
| 2202 | HD 2.7m Trap Platform | 20.8 | | 2 | | | | 2 | | |
| 2071 | HD D/W Timber Toeboard End | 5.2 | 1 | | | 1 | 1 | | | 1 |
| 2069 | HD 1.8m Timber Toeboard Side | 7.3 | 2 | | | | 2 | | | |
| 2086 | HD 1.8m Timber Toeboard Side - Linked | 8.0 | | | 2 | | | | 2 | |
| 2087 | HD 2.7m Timber Toeboard Side - Linked | 12.0 | | 2 | | | | 2 | | |
| 2074 | HD Toeboard Corner Bracket | 0.9 | 2 | | | 2 | 2 | | | 2 |
| 2079 | HD Toeboard Inline Bracket | 0.8 | 2 | 2 | 2 | -2 | 2 | 2 | 2 | -2 |
| 2056 | HD Small Stabiliser | 5.9 | 4 | | 4 | | | | | |
| 2057 | HD Large Stabiliser | 7.6 | | | | | 4 | | 4 | |
| TOTAL SELF WEIGHT OF TOWER (KGS) | | | 274 | 173 | 269 | 2 | 355 | 228 | 351 | -1 |

Component Schedule

Double width linked tower assembly using 1.8m towers & 2.7m link decks

Build Method 'D'

This schedule shows the parts required for each bay of linked tower structures for the heights shown assuming that access is required at one end of the structure only. Each structure is defined as a starter tower with any number of additional bays. Counting from the starter tower as "1", bays will either be even or odd numbers. The end bay will always be an odd number and the relevant part changes are shown to produce the correct end configuration. Parts table assumes one working level. For additional working levels, add toeboards and corner clips based on table quantities.

| CODE | PART DESCRIPTION | Wt | 3.4m Platform Height | | | | 5.4m Platform Height | | | | 7.4m Platform Height | | | |
|----------------------------------|---------------------------------------|------|----------------------|----------|---------|---------|----------------------|----------|---------|---------|----------------------|----------|---------|---------|
| | | | Start Tower | Even Bay | Odd Bay | End Bay | Start Tower | Even Bay | Odd Bay | End Bay | Start Tower | Even Bay | Odd Bay | End Bay |
| 2233 | HD Adj. Swivel Base Jack | 2.2 | 4 | | 4 | | 4 | | 4 | | 4 | | 4 | |
| 2001 | HD 1.4m Base Frame | 12.9 | 1 | | 1 | | 1 | | 1 | | 1 | | 1 | |
| 2212 | HD 1.4m 5 Rung Ladder Frame | 14.7 | 1 | | 1 | | 1 | | 1 | | 1 | | 1 | |
| 2002 | HD 1.4m Main Frame | 10.9 | | | | 1 | | | | 2 | | | | 3 |
| 2213 | HD 1.4m 4 Rung Ladder Frame | 12.9 | 1 | | | | 2 | | | | 3 | | | |
| 2009 | HD 1.4m Walkthru' "H" Frame | 10.3 | 1 | | 2 | -1 | 2 | | 4 | -2 | 3 | | 6 | -3 |
| 2010 | HD 1.4m Walkthru' Frame Gate | 3.8 | 1 | | 2 | -1 | 2 | | 4 | -2 | 3 | | 6 | -3 |
| 2071 | HD D/W Timber Toeboard End | 5.2 | 1 | | | 1 | 1 | | | 1 | 1 | | | 1 |
| 2069 | HD 1.8m Timber Toeboard Side | 7.3 | 2 | | | | 2 | | | | 2 | | | |
| 2086 | HD 1.8m Timber Toeboard Side - Linked | 8.0 | | | 2 | | | | 2 | | | | 2 | |
| 2087 | HD 2.7m Timber Toeboard Side - Linked | 12.0 | | 2 | | | | 2 | | | | 2 | | |
| 2074 | HD Toeboard Corner Bracket | 0.9 | 2 | | | 2 | 2 | | | 2 | 2 | | | 2 |
| 2079 | HD Toeboard Inline Bracket | 0.8 | 2 | 2 | 2 | -2 | 2 | 2 | 2 | -2 | 2 | 2 | 2 | -2 |
| 2040 | HD 1.8m Brace | 2.6 | 11 | | 11 | | 15 | | 15 | | 19 | | 19 | |
| 2041 | HD 2.7m Brace | 3.6 | 4 | 11 | 4 | | 6 | 15 | 6 | | 8 | 19 | 8 | |
| 2044 | HD 2.7m Platform | 20.4 | | 2 | | | | 4 | | | | 6 | | |
| 2202 | HD 2.7m Trap Platform | 20.8 | | 1 | | | | 1 | | | | 1 | | |
| 2043 | HD 1.8m Platform | 14.4 | 1 | | 2 | | 2 | | 4 | | 3 | | 6 | |
| 2201 | HD 1.8m Trap Platform | 14.8 | 2 | | 1 | | 3 | | 1 | | 4 | | 1 | |
| 2056 | HD Small Stabiliser | 5.9 | 4 | | 4 | | 4 | | 4 | | | | | |
| 2057 | HD Large Stabiliser | 7.6 | | | | | | | | | 4 | | 4 | |
| TOTAL SELF WEIGHT OF TOWER (KGS) | | | 197 | 127 | 192 | 2 | 271 | 182 | 267 | -1 | 352 | 238 | 349 | -5 |

Component Schedule

Double width linked tower assembly using 2.7m towers & 2.7m link decks

Build Method 'A'

This schedule shows the parts required for each bay of linked tower structures for the heights shown assuming that access is required at one end of the structure only. Each structure is defined as a starter tower with any number of additional bays. Counting from the starter tower as "1", bays will either be even or odd numbers. The end bay will always be an odd number and the relevant part changes are shown to produce the correct end configuration. Parts table assumes one working level. For additional working levels, add toeboards and corner clips based on table quantities.

| CODE | PART DESCRIPTION | Wt | 4.4m Platform Height | | | | 6.4m Platform Height | | | | 8.4m Platform Height | | | |
|----------------------------------|---------------------------------------|------|----------------------|----------|---------|---------|----------------------|----------|---------|---------|----------------------|----------|---------|---------|
| | | | Start Tower | Even Bay | Odd Bay | End Bay | Start Tower | Even Bay | Odd Bay | End Bay | Start Tower | Even Bay | Odd Bay | End Bay |
| 2233 | HD Adj. Swivel Base Jack | 2.2 | 4 | | 4 | | 4 | | 4 | | 4 | | 4 | |
| 2001 | HD 1.4m Base Frame | 12.9 | 1 | | 1 | | 1 | | 1 | | 1 | | 1 | |
| 2212 | HD 1.4m 5 Rung Ladder Frame | 14.7 | 1 | | 1 | | 1 | | 1 | | 1 | | 1 | |
| 2002 | HD 1.4m Main Frame | 10.9 | | | | 1 | | | | 2 | | | | 3 |
| 2213 | HD 1.4m 4 Rung Ladder Frame | 12.9 | 1 | | | | 2 | | | | 3 | | | |
| 2008 | HD 1.4m 1/2 Frame | 5.6 | 1 | | 1 | | 1 | | 1 | | 1 | | 1 | |
| 2215 | HD 1.4m 2 Rung Ladder Frame | 6.6 | 1 | | 1 | | 1 | | 1 | | 1 | | 1 | |
| 2009 | HD 1.4m Walkthru' "H" Frame | 10.3 | 1 | | 2 | -1 | 2 | | 4 | -2 | 3 | | 6 | -3 |
| 2010 | HD 1.4m Walkthru' Frame Gate | 3.8 | 1 | | 2 | -1 | 2 | | 4 | -2 | 3 | | 6 | -3 |
| 2041 | HD 2.7m Brace | 3.6 | 12 | 12 | 12 | | 16 | 16 | 16 | | 20 | 20 | 20 | |
| 2042 | HD 3.3m Brace | 4.4 | 4 | | 4 | | 6 | | 6 | | 8 | | 8 | |
| 2083 | HD 2.7m x 3 Rung Brace (Black) | 4.1 | 2 | | 2 | | 2 | | 2 | | 2 | | 2 | |
| 2044 | HD 2.7m Platform | 20.4 | 1 | 2 | 2 | | 2 | 4 | 4 | | 3 | 6 | 6 | |
| 2202 | HD 2.7m Trap Platform | 20.8 | 2 | 1 | 1 | | 3 | 1 | 1 | | 4 | 1 | 1 | |
| 2071 | HD D/W Timber Toeboard End | 5.2 | 1 | | | 1 | 1 | | | 1 | 1 | | | 1 |
| 2070 | HD 2.7m Timber Toeboard Side | 11.3 | 2 | | | | 2 | | | | 2 | | | |
| 2087 | HD 2.7m Timber Toeboard Side - Linked | 12.0 | | 2 | 2 | | | 2 | 2 | | | 2 | 2 | |
| 2074 | HD Toeboard Corner Bracket | 0.9 | 2 | | | 2 | 2 | | | 2 | 2 | | | 2 |
| 2079 | HD Toeboard Inline Bracket | 0.8 | 2 | 2 | 2 | -2 | 2 | 2 | 2 | -2 | 2 | 2 | 2 | -2 |
| 2056 | HD Small Stabiliser | 5.9 | 4 | | 4 | | 4 | | 4 | | | | | |
| 2057 | HD Large Stabiliser | 7.6 | | | | | | | | | 4 | | 4 | |
| TOTAL SELF WEIGHT OF TOWER (KGS) | | | 261 | 131 | 257 | 2 | 353 | 186 | 349 | -1 | 452 | 241 | 448 | -5 |

Component Schedule

Double width linked tower assembly using 2.7m towers & 2.7m link decks

Build Method 'B'

This schedule shows the parts required for each bay of linked tower structures for the heights shown assuming that access is required at one end of the structure only. Each structure is defined as a starter tower with any number of additional bays. Counting from the starter tower as "1", bays will either be even or odd numbers. The end bay will always be an odd number and the relevant part changes are shown to produce the correct end configuration. Parts table assumes one working level. For additional working levels, add toeboards and corner clips based on table quantities.

| CODE | PART DESCRIPTION | Wt | 4.9m Platform Height | | | | 6.9m Platform Height | | | |
|----------------------------------|---------------------------------------|------|----------------------|----------|---------|---------|----------------------|----------|---------|---------|
| | | | Start Tower | Even Bay | Odd Bay | End Bay | Start Tower | Even Bay | Odd Bay | End Bay |
| 2233 | HD Adj. Swivel Base Jack | 2.2 | 4 | | 4 | | 4 | | 4 | |
| 2001 | HD 1.4m Base Frame | 12.9 | 1 | | 1 | | 1 | | 1 | |
| 2212 | HD 1.4m 5 Rung Ladder Frame | 14.7 | 1 | | 1 | | 1 | | 1 | |
| 2002 | HD 1.4m Main Frame | 10.9 | | | | 1 | | | | 2 |
| 2213 | HD 1.4m 4 Rung Ladder Frame | 12.9 | 1 | | | | 2 | | | |
| 2006 | HD 1.4m 3/4 Frame | 8.2 | 1 | | 1 | | 1 | | 1 | |
| 2214 | HD 1.4m 3 Rung Ladder Frame | 9.8 | 1 | | 1 | | 1 | | 1 | |
| 2009 | HD 1.4m Walkthru' "H" Frame | 10.3 | 1 | | 2 | -1 | 2 | | 4 | -2 |
| 2010 | HD 1.4m Walkthru' Frame Gate | 3.8 | 1 | | 2 | -1 | 2 | | 4 | -2 |
| 2041 | HD 2.7m Brace | 3.6 | 13 | 13 | 13 | | 17 | 17 | 17 | |
| 2042 | HD 3.3m Brace | 4.4 | 4 | | 4 | | 6 | | 6 | |
| 2083 | HD 2.7m x 3 Rung Brace (Black) | 4.1 | 2 | | 2 | | 2 | | 2 | |
| 2044 | HD 2.7m Platform | 20.4 | 1 | 2 | 2 | | 2 | 4 | 4 | |
| 2202 | HD 2.7m Trap Platform | 20.8 | 2 | 1 | 1 | | 3 | 1 | 1 | |
| 2071 | HD D/W Timber Toeboard End | 5.2 | 1 | | | 1 | 1 | | | 1 |
| 2070 | HD 2.7m Timber Toeboard Side | 11.3 | 2 | | | | 2 | | | |
| 2087 | HD 2.7m Timber Toeboard Side - Linked | 12.0 | | 2 | 2 | | | 2 | 2 | |
| 2074 | HD Toeboard Corner Bracket | 0.9 | 2 | | | 2 | 2 | | | 2 |
| 2079 | HD Toeboard Inline Bracket | 0.8 | 2 | 2 | 2 | -2 | 2 | 2 | 2 | -2 |
| 2056 | HD Small Stabiliser | 5.9 | 4 | | 4 | | 4 | | 4 | |
| TOTAL SELF WEIGHT OF TOWER (KGS) | | | 271 | 134 | 266 | 2 | 362 | 190 | 358 | -1 |

Component Schedule

Double width linked tower assembly using 2.7m towers & 2.7m link decks

Build Method 'C'

This schedule shows the parts required for each bay of linked tower structures for the heights shown assuming that access is required at one end of the structure only. Each structure is defined as a starter tower with any number of additional bays. Counting from the starter tower as "1", bays will either be even or odd numbers. The end bay will always be an odd number and the relevant part changes are shown to produce the correct end configuration. Parts table assumes one working level. For additional working levels, add toeboards and corner clips based on table quantities.

| CODE | PART DESCRIPTION | Wt | 5.9m Platform Height | | | | 7.9m Platform Height | | | |
|----------------------------------|---------------------------------------|------|----------------------|----------|---------|---------|----------------------|----------|---------|---------|
| | | | Start Tower | Even Bay | Odd Bay | End Bay | Start Tower | Even Bay | Odd Bay | End Bay |
| 2233 | HD Adj. Swivel Base Jack | 2.2 | 4 | | 4 | | 4 | | 4 | |
| 2001 | HD 1.4m Base Frame | 12.9 | 1 | | 1 | | 1 | | 1 | |
| 2212 | HD 1.4m 5 Rung Ladder Frame | 14.7 | 1 | | 1 | | 1 | | 1 | |
| 2002 | HD 1.4m Main Frame | 10.9 | | | | 1 | | | | 2 |
| 2213 | HD 1.4m 4 Rung Ladder Frame | 12.9 | 1 | | | | 2 | | | |
| 2006 | HD 1.4m 3/4 Frame | 8.2 | 1 | | 1 | | 1 | | 1 | |
| 2214 | HD 1.4m 3 Rung Ladder Frame | 9.8 | 1 | | 1 | | 1 | | 1 | |
| 2008 | HD 1.4m 1/2 Frame | 5.6 | 1 | | 1 | | 1 | | 1 | |
| 2215 | HD 1.4m 2 Rung Ladder Frame | 6.6 | 1 | | 1 | | 1 | | 1 | |
| 2009 | HD 1.4m Walkthru' "H" Frame | 10.3 | 1 | | 2 | -1 | 2 | | 4 | -2 |
| 2010 | HD 1.4m Walkthru' Frame Gate | 3.8 | 1 | | 2 | -1 | 2 | | 4 | -2 |
| 2041 | HD 2.7m Brace | 3.6 | 18 | 18 | 18 | | 22 | 22 | 22 | |
| 2042 | HD 3.3m Brace | 4.4 | 4 | | 4 | | 6 | | 6 | |
| 2083 | HD 2.7m x 3 Rung Brace (Black) | 4.1 | 4 | | 4 | | 4 | | 4 | |
| 2044 | HD 2.7m Platform | 20.4 | 1 | 2 | 2 | | 2 | 4 | 4 | |
| 2202 | HD 2.7m Trap Platform | 20.8 | 3 | 2 | 2 | | 4 | 2 | 2 | |
| 2071 | HD D/W Timber Toeboard End | 5.2 | 1 | | | 1 | 1 | | | 1 |
| 2070 | HD 2.7m Timber Toeboard Side | 11.3 | 2 | | | | 2 | | | |
| 2087 | HD 2.7m Timber Toeboard Side - Linked | 12.0 | | 2 | 2 | | | 2 | 2 | |
| 2074 | HD Toeboard Corner Bracket | 0.9 | 2 | | | 2 | 2 | | | 2 |
| 2079 | HD Toeboard Inline Bracket | 0.8 | 2 | 2 | 2 | -2 | 2 | 2 | 2 | -2 |
| 2056 | HD Small Stabiliser | 5.9 | 4 | | 4 | | | | | |
| 2057 | HD Large Stabiliser | 7.6 | | | | | 4 | | 4 | |
| TOTAL SELF WEIGHT OF TOWER (KGS) | | | 330 | 173 | 325 | 2 | 429 | 228 | 425 | -1 |

Component Schedule

Double width linked tower assembly using 2.7m towers & 2.7m link decks

Build Method 'D'

This schedule shows the parts required for each bay of linked tower structures for the heights shown assuming that access is required at one end of the structure only. Each structure is defined as a starter tower with any number of additional bays. Counting from the starter tower as "1", bays will either be even or odd numbers. The end bay will always be an odd number and the relevant part changes are shown to produce the correct end configuration. Parts table assumes one working level. For additional working levels, add toeboards and corner clips based on table quantities.

| CODE | PART DESCRIPTION | Wt | 3.4m Platform Height | | | | 5.4m Platform Height | | | | 7.4m Platform Height | | | |
|----------------------------------|---------------------------------------|------|----------------------|----------|---------|---------|----------------------|----------|---------|---------|----------------------|----------|---------|---------|
| | | | Start Tower | Even Bay | Odd Bay | End Bay | Start Tower | Even Bay | Odd Bay | End Bay | Start Tower | Even Bay | Odd Bay | End Bay |
| 2233 | HD Adj. Swivel Base Jack | 2.2 | 4 | | 4 | | 4 | | 4 | | 4 | | 4 | |
| 2001 | HD 1.4m Base Frame | 12.9 | 1 | | 1 | | 1 | | 1 | | 1 | | 1 | |
| 2212 | HD 1.4m 5 Rung Ladder Frame | 14.7 | 1 | | 1 | | 1 | | 1 | | 1 | | 1 | |
| 2002 | HD 1.4m Main Frame | 10.9 | | | | 1 | | | | 2 | | | | 3 |
| 2213 | HD 1.4m 4 Rung Ladder Frame | 12.9 | 1 | | | | 2 | | | | 3 | | | |
| 2009 | HD 1.4m Walkthru' "H" Frame | 10.3 | 1 | | 2 | -1 | 2 | | 4 | -2 | 3 | | 6 | -3 |
| 2010 | HD 1.4m Walkthru' Frame Gate | 3.8 | 1 | | 2 | -1 | 2 | | 4 | -2 | 3 | | 6 | -3 |
| 2071 | HD D/W Timber Toeboard End | 5.2 | 1 | | | 1 | 1 | | | 1 | 1 | | | 1 |
| 2070 | HD 2.7m Timber Toeboard Side | 11.3 | 2 | | | | 2 | | | | 2 | | | |
| 2087 | HD 2.7m Timber Toeboard Side - Linked | 12.0 | | 2 | 2 | | | 2 | 2 | | | 2 | 2 | |
| 2074 | HD Toeboard Corner Bracket | 0.9 | 2 | | | 2 | 2 | | | 2 | 2 | | | 2 |
| 2079 | HD Toeboard Inline Bracket | 0.8 | 2 | 2 | 2 | -2 | 2 | 2 | 2 | -2 | 2 | 2 | 2 | -2 |
| 2041 | HD 2.7m Brace | 3.6 | 11 | 11 | 11 | | 15 | 15 | 15 | | 19 | 19 | 19 | |
| 2042 | HD 3.3m Brace | 4.4 | 4 | | 4 | | 6 | | 6 | | 8 | | 8 | |
| 2044 | HD 2.7m Platform | 20.4 | 1 | 2 | 2 | | 2 | 4 | 4 | | 3 | 6 | 6 | |
| 2202 | HD 2.7m Trap Platform | 20.8 | 2 | 1 | 1 | | 3 | 1 | 1 | | 4 | 1 | 1 | |
| 2056 | HD Small Stabiliser | 5.9 | 4 | | 4 | | 4 | | 4 | | | | | |
| 2057 | HD Large Stabiliser | 7.6 | | | | | | | | | 4 | | 4 | |
| TOTAL SELF WEIGHT OF TOWER (KGS) | | | 237 | 127 | 233 | 2 | 329 | 182 | 325 | -1 | 428 | 238 | 424 | -5 |

ASSEMBLY INSTRUCTIONS - All Platform Working Heights

Step 1

Insert the base jacks into the base of the 5 Rung Base Frame and 5 Rung Ladder Frame. Ensure the spring-loaded pin is engaged into the hole in the side of the frame uprights.



Step 2

Connect 2 horizontal braces to the uprights of the first frame in the area just above the bottom rung. Make sure that the braces are connected from the inside of the tower facing outwards. Make sure that the frame head fittings are pointing inwards into the tower.



Step 3

Connect the 2nd frame to the horizontal braces in the same position that they are located on the first frames. Ensure that the braces are at the lowest part of the upright - resting on the horizontal rungs for the frame. Now square the tower and level using a spirit level by twisting the serrated collar on the base jack to adjust the height of each leg.





Step 4

Connect 2 standard diagonal braces to the frames as shown. Keep the diagonal braces as close to the frame uprights as possible. Ensure that they run in opposite directions to each other.



Step 5

Install 2 horizontal braces onto the top rungs of the frames. Make sure they are positioned inside of the diagonal braces but as close to the diagonal brace as possible.



Step 6

Install a trap platform on the ladder side of the tower with the trapdoor at the same end as the ladder frame. Engage the wind latches on the underside of the platform at both ends. Using either the 3T method or from the ground, clip on 3 more horizontal braces in the positions shown - to give the platform a total of 4 horizontal guardrails.

Step 7

Connect another ladder frame and base jacks to the existing tower's plain frame using 2 horizontal braces. Make sure the ladder frame is orientated as shown. Clip these to the bottom horizontal rungs of the frames. Make sure there is enough room on the new frame between the new brace hook and the frame upright to fit a diagonal brace and another horizontal brace when assembling the next bay - see zoomed in image.

SAFETY NOTE: One person should keep holding the new ladder frame upright until the next stage is in progress.

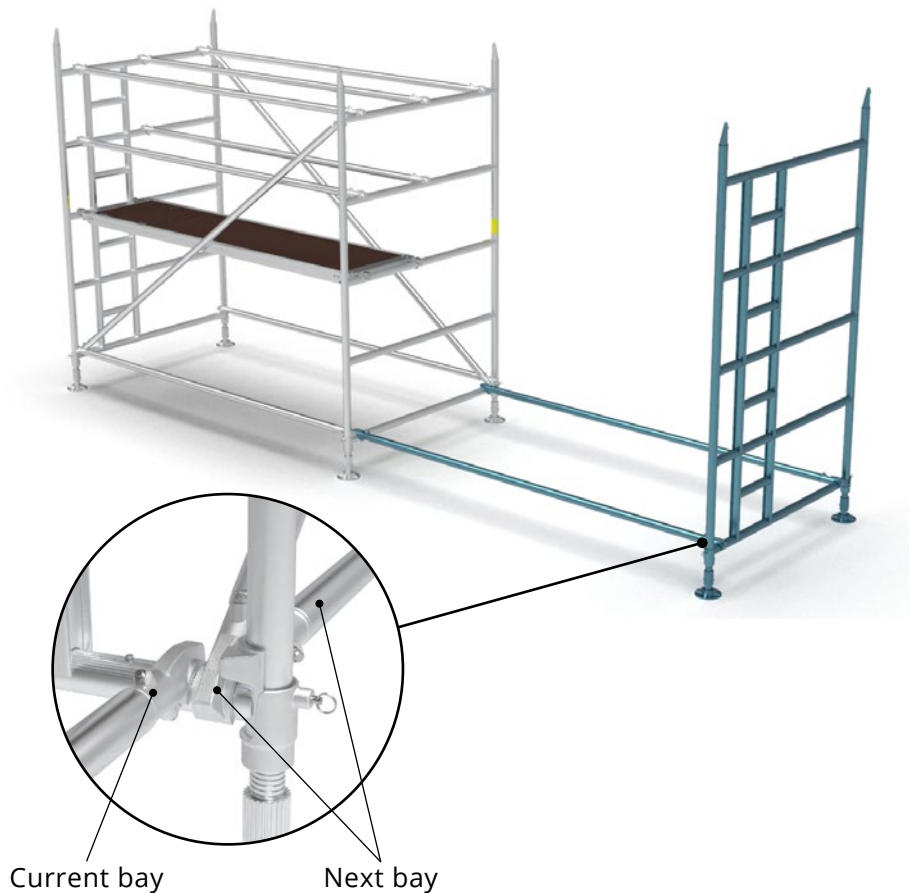

Step 8

Now install a trap platform in-line with the previous bay's platform - orientated so the trap door is at the end by the ladder. Ensure the wind latches are fully engaged. Using either the 3T method or from the ground, clip on 4 horizontal braces to give the platform 4 horizontal guardrails. Finally, install another horizontal brace on the top rung of the bay - on the opposite side to the platform. Now square and level the bay.



Repeat steps 2 to 8 until the required length of linked tower assembly has been created.

STABILISER INSTALLATION

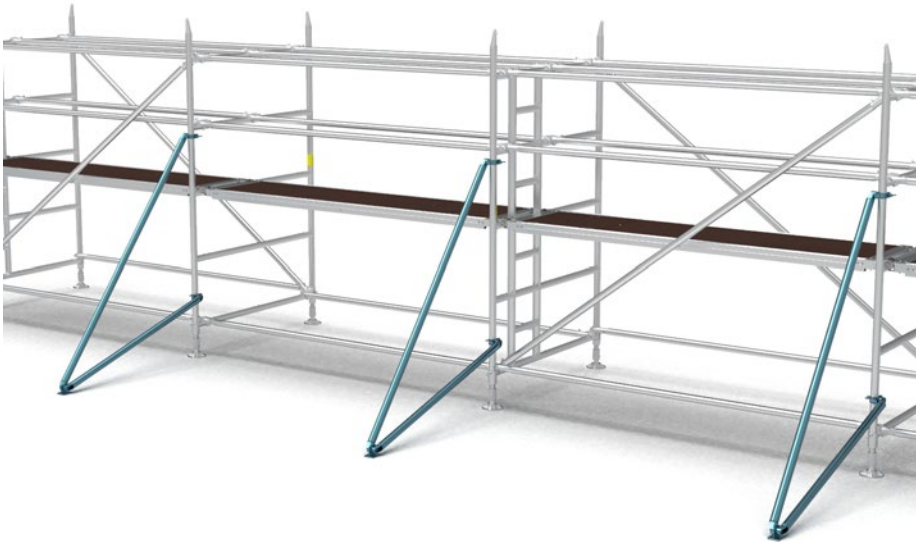

Step 9A - Linked towers against a façade:

Once all the bays are in position and level, connect a relevant sized stabiliser to every frame upright, on the non-working face of the tower. Firstly, fix the shorter arm to the lowest part of the frame, then connect the longer arm to the upper part of the framework, ensuring the foot is firmly placed on the ground. Make sure the couplers are fully tightened. Small vertical adjustments up and down can be made to either arm to guarantee a sturdy placement.

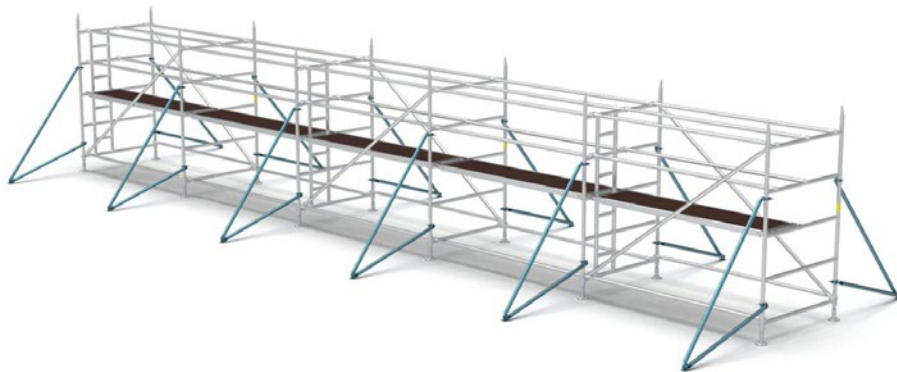

Step 9B - Linked towers free standing:

Once all the bays are in position and level, connect a relevant sized stabiliser to every frame upright, on both sides of the tower. Firstly, fix the shorter arm to the lowest part of the frame, then connect the longer arm to the upper part of the framework, ensuring the foot is firmly placed on the ground. Make sure the couplers are fully tightened. Small vertical adjustments up and down can be made to either arm to guarantee a sturdy placement.

NOTE: Stabilisers have been omitted from the images in all future steps for clarity only.

**For the Build Method D - 3.4m, 5.4m, 7.4m - proceed to step 11.
For all other linked tower heights, please see the relevant build method below.**

Build Method A 4.4m, 6.4m, 8.4m

Step 10.1

Working from the temporary platform on the starting tower, install 2 rung main and ladder frames in appropriate positions onto the base frames. Then, clip 2 coloured diagonal braces (blue or black) onto the top rungs as shown. The other end of the brace connects to the 3rd rung down on the opposite side. Diagonal braces always run in a parallel direction to the diagonal braces below. Repeat this process in all of the diagonally braced bays in the assembly.

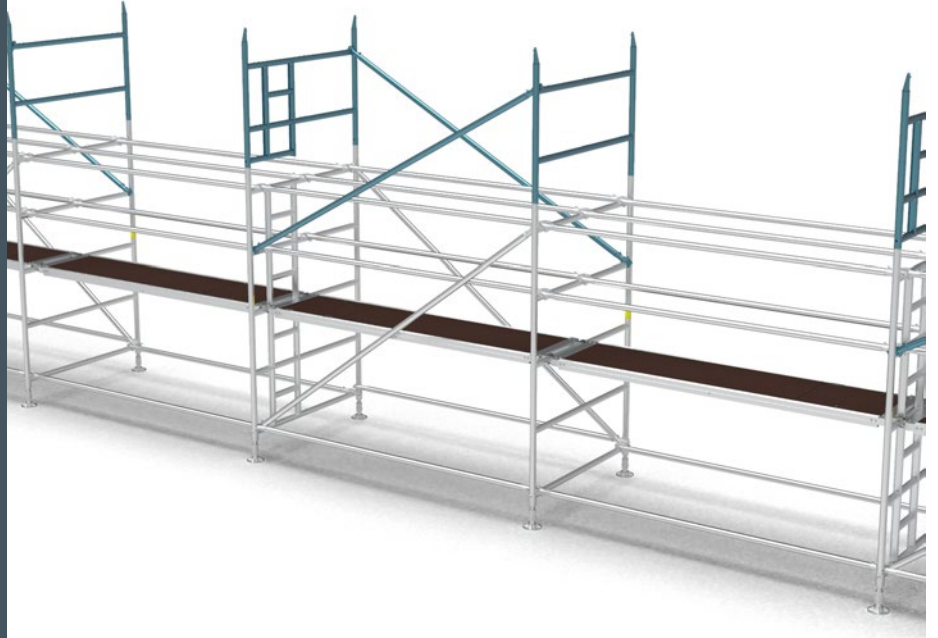

Step 10.2

Install another 4 guard rails above the 4 already in place, for when the platform is relocated.

Repeat this process all along the assembly.

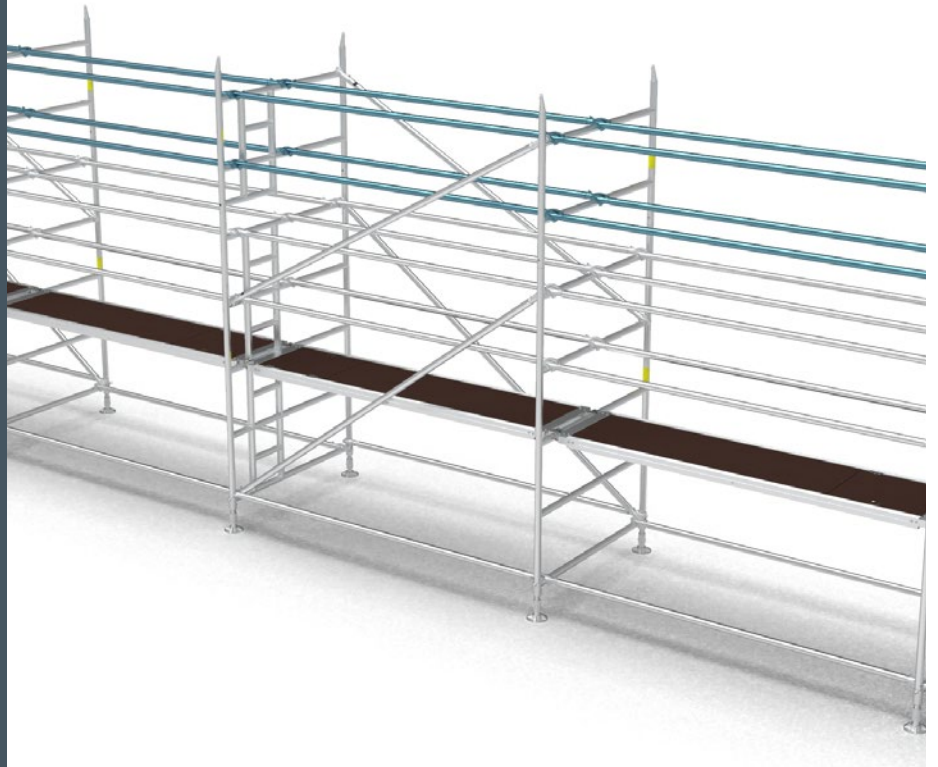

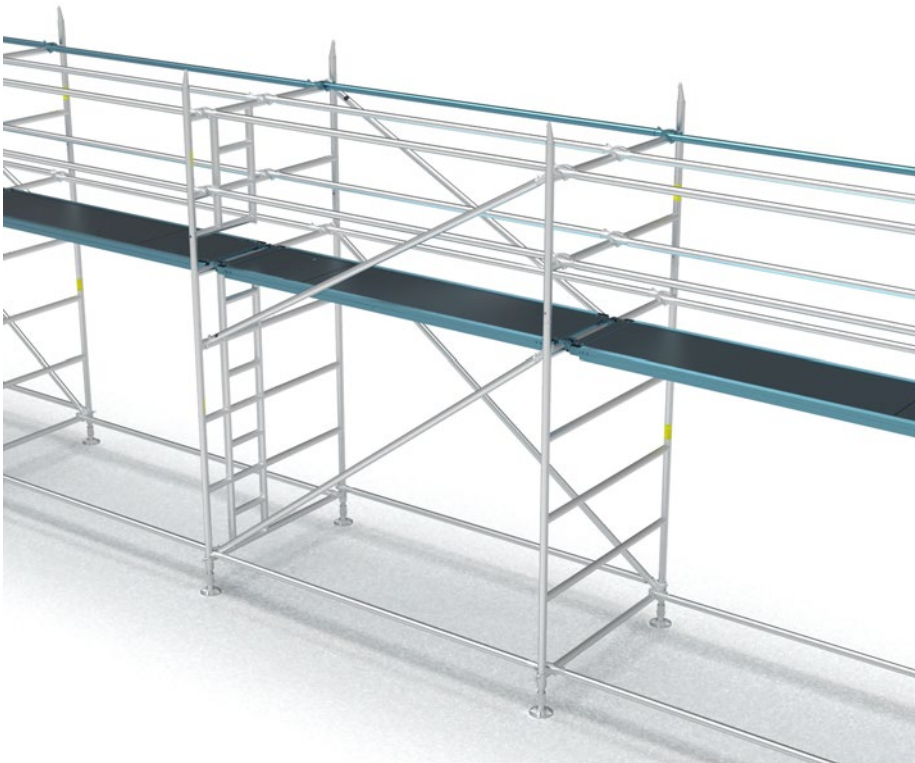

Step 10.3

Remove the lower 4 guardrails by using the 3T method or uninstalling them from the ground. Now relocate the platform to the top rung of the base frames along the tower. Ensure the trap door is located next to the ladder and that the wind latches are fully engaged.

Working from this platform, install another horizontal brace on the opposite side of the tower to the platform guardrails - on the top rung as shown.

Proceed to step 11

Build Method B 4.9m, 6.9m

Step 10.1

Working from the temporary platform on the starting tower, install a 3 rung main frame & a 3 rung ladder frame in appropriate positions onto the base frames. Then, clip 2 coloured diagonal braces (blue or black) onto the top rungs as shown. The other end of the brace connects to the 3rd rung down on the opposite side. Diagonal braces always run in a parallel direction to the diagonal braces below. Repeat this process in all of the diagonally braced bays in the assembly.

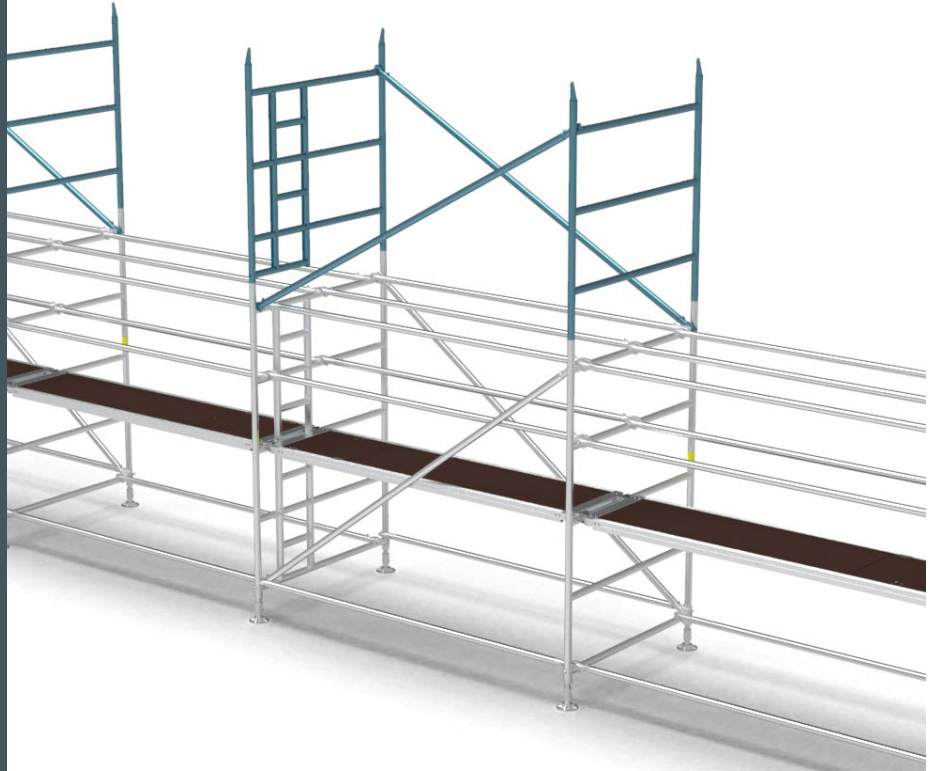

Step 10.2

Relocate the platform and guardrails down one rung. Now add an additional horizontal brace above the outside 2 horizontal braces - on the top rung of the bottom frames. Working from this new location, install a trap platform 4 rungs above. Ensure the trap door is located next to the ladder and that the wind latches are fully engaged. Repeat this process in every bay along the assembly.

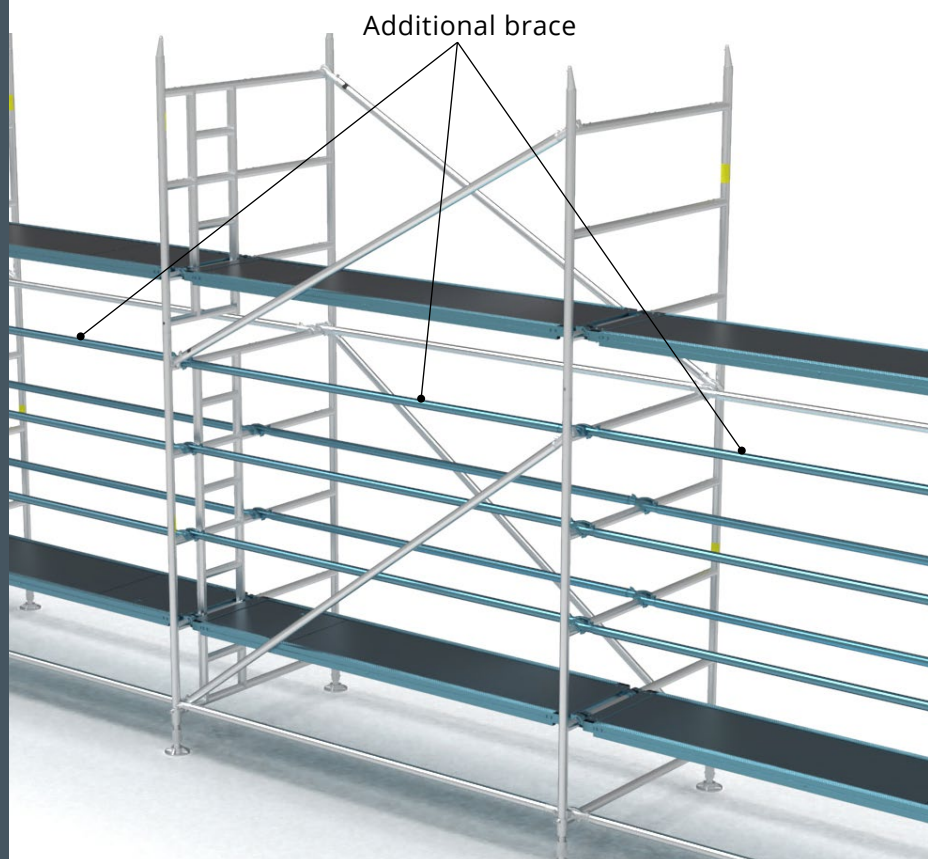

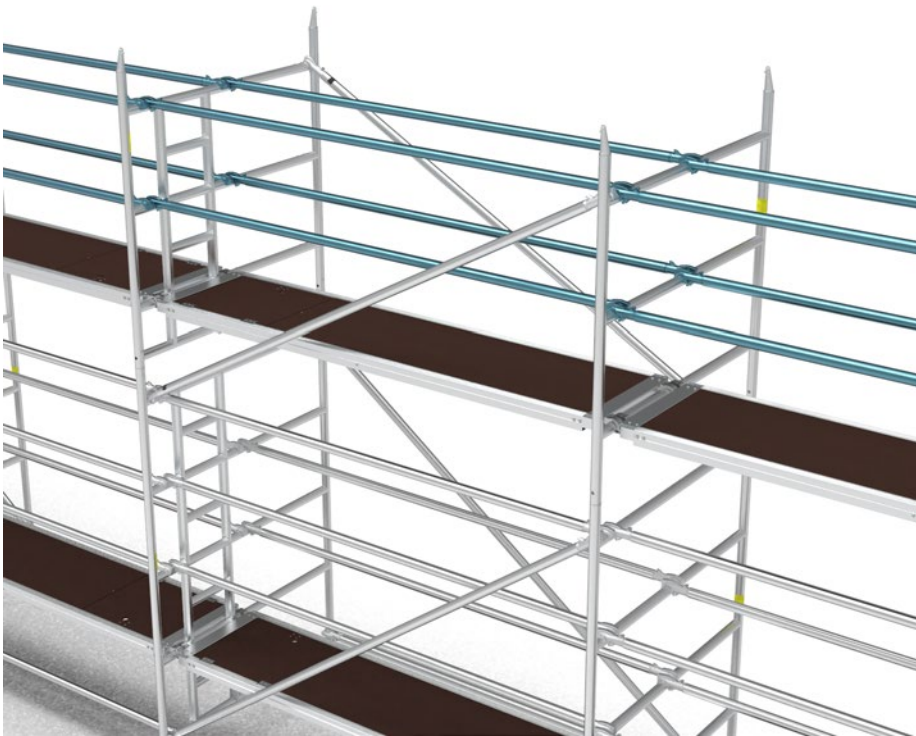

Step 10.3

Starting from one end of the tower run, install 4 guardrails to the upper platform using the 3T method.

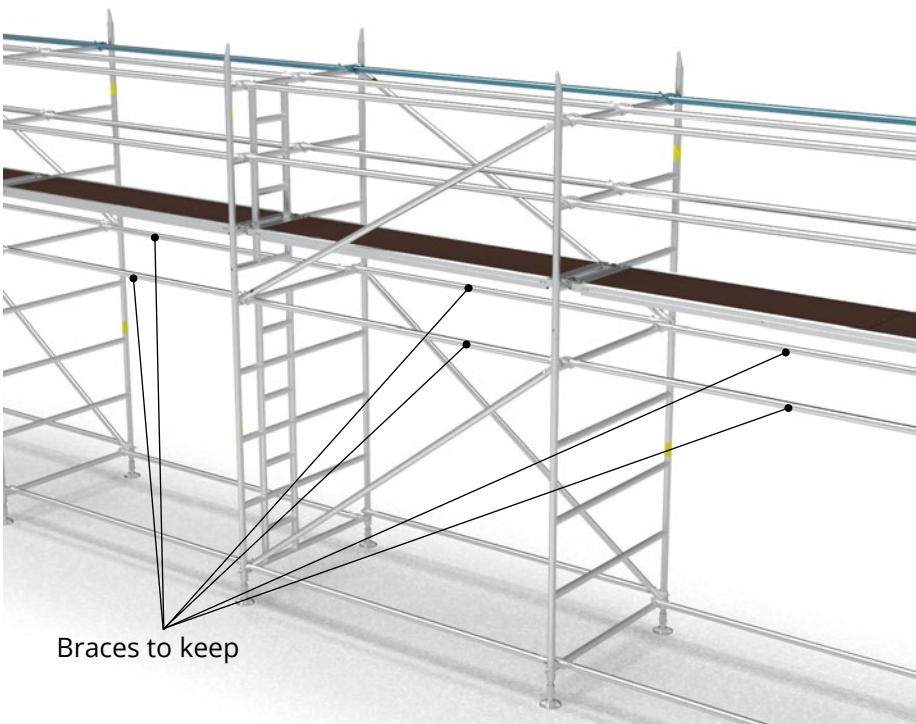

Step 10.4

Working from the top platform, install another horizontal brace on the opposite side of the tower to the platform guardrails - on the top rung as shown. The temporary platform and 4 guardrails at the base of the tower can now be removed. Ensure the 2 horizontal braces on the top rung of the base frames are left installed. Repeat this process all along the assembly.

Proceed to step 11

Build Method C 5.9m, 7.9m

Step 10.1

Working from the temporary platform on the starting tower, install a 2 rung main frame & a 2 rung ladder frame in appropriate positions onto the base frames. Then, clip 2 coloured diagonal braces (blue or black) onto the top rungs as shown. The other end of the brace connects to the 3rd rung down on the opposite side. Diagonal braces always run in a parallel direction to the diagonal braces below. Repeat this process in all of the diagonally braced bays in the assembly.

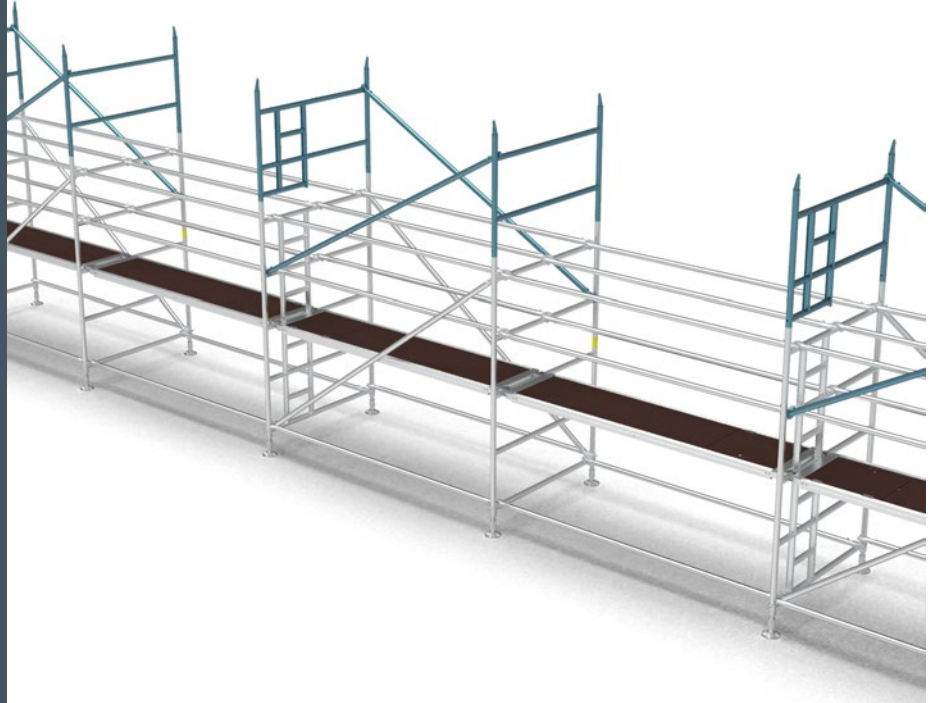

Step 10.2

Starting from one end of the tower run, relocate the platform and 4 guardrails up 2 rungs. Ensure the trap door is located next to the ladder and that the wind latches are fully engaged.

Working from the new platform position, install another horizontal brace on the opposite side of the tower to the platform guardrails - on the top rung as shown. The diagonal braces on the tower should be as close to the frame uprights as possible, and then the horizontal braces.

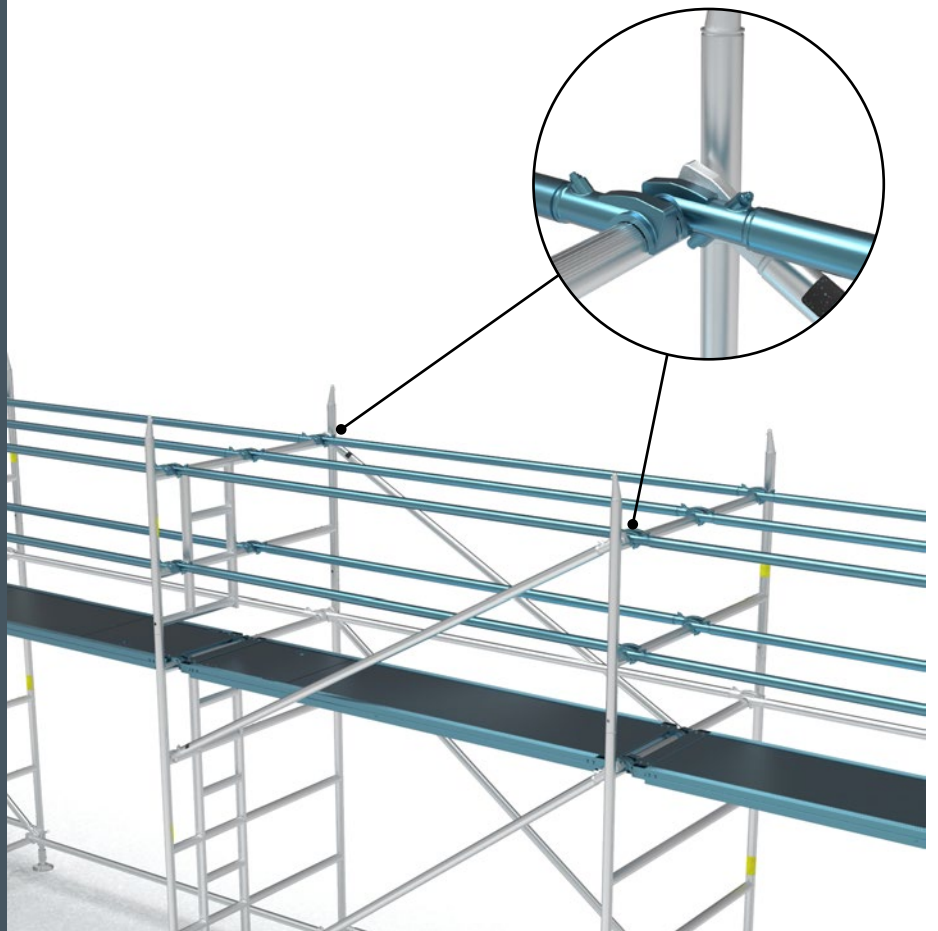

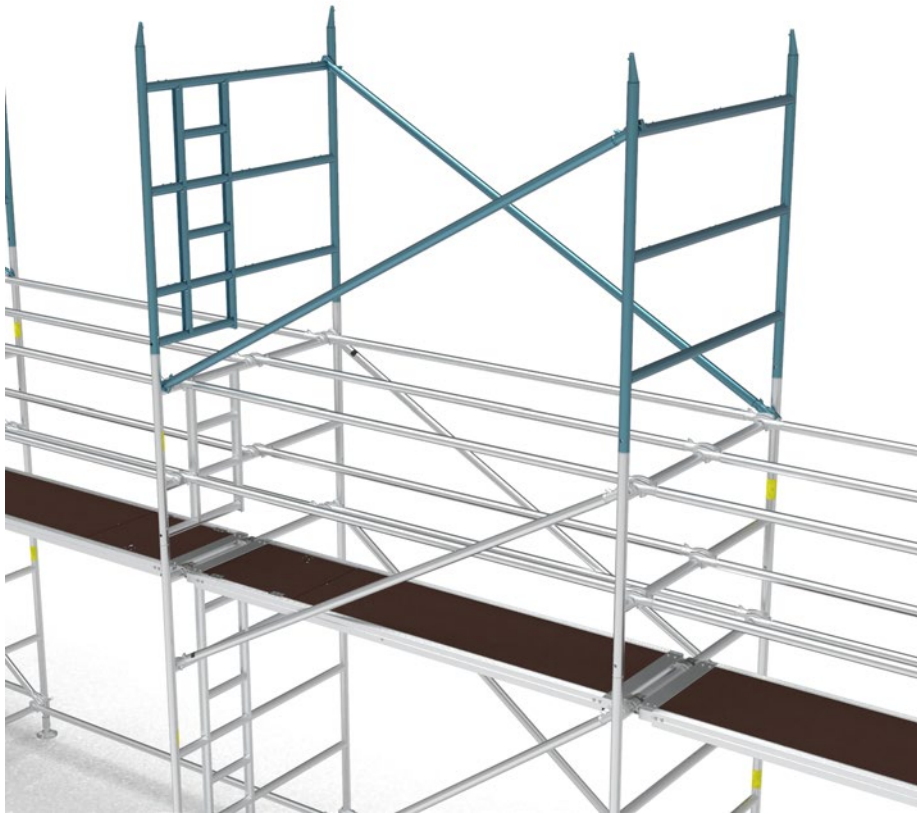

Step 10.3

Install a 3 rung main frame & a 3 rung ladder frame in appropriate positions onto the 2 rung frames. Then, clip 2 coloured diagonal braces (blue or black) onto the top rungs as shown. The other end of the brace connects to the 3rd rung down on the opposite side. Diagonal braces always run in a parallel direction to the diagonal braces below. Repeat this process in all of the diagonally braced bays in the assembly. The diagonal braces on the tower should be as close to the frame uprights as possible.

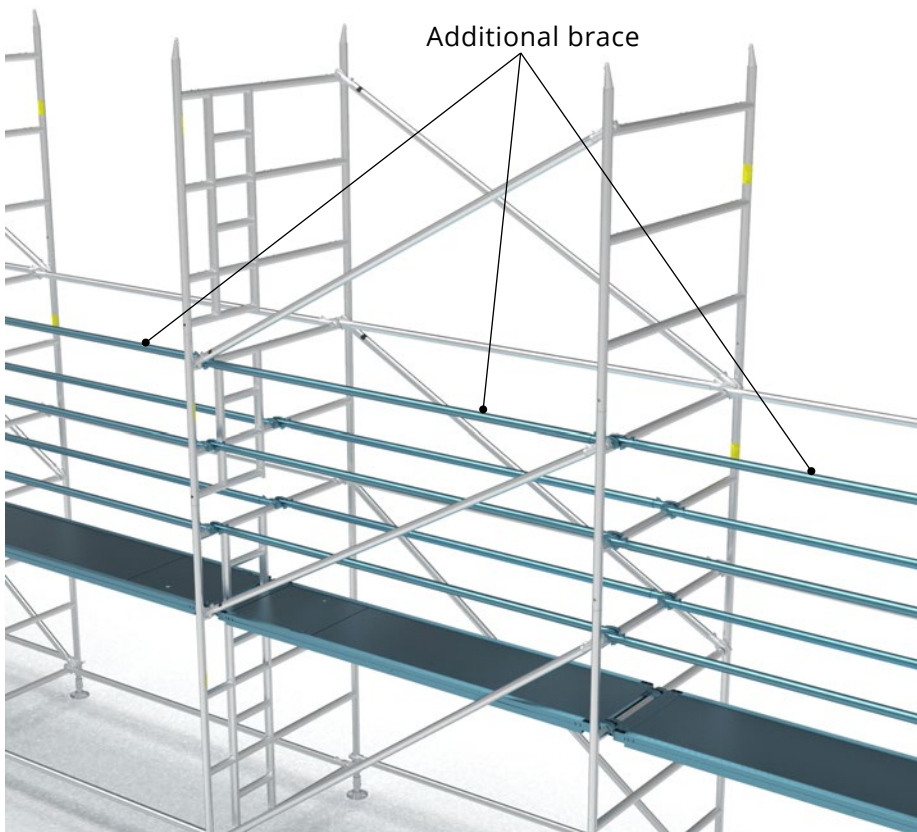

Step 10.4

Relocate the platform and the 4 guardrails down one rung. Now add an additional horizontal brace above the outside 2 horizontal braces - on the top rung of the 2 rung frames.

Step 10.5

Working from this new location, install a trap platform 4 rungs above. Ensure the trap door is located next to the ladder and that the wind latches are fully engaged. Now using the 3T method, install 4 guardrails. Repeat this process in every bay along the assembly.

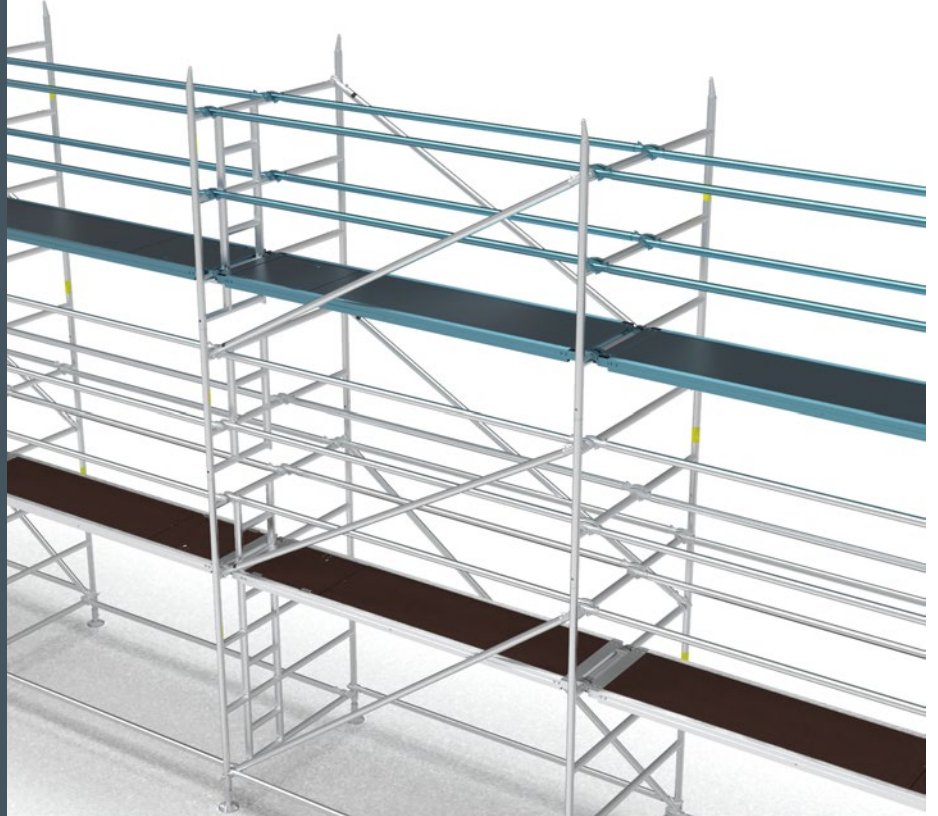

Step 10.6

Working from the top platform, install another horizontal brace on the opposite side of the tower to the platform guardrails - on the top rung as shown. Repeat this process all along the assembly.

Proceed to step 11

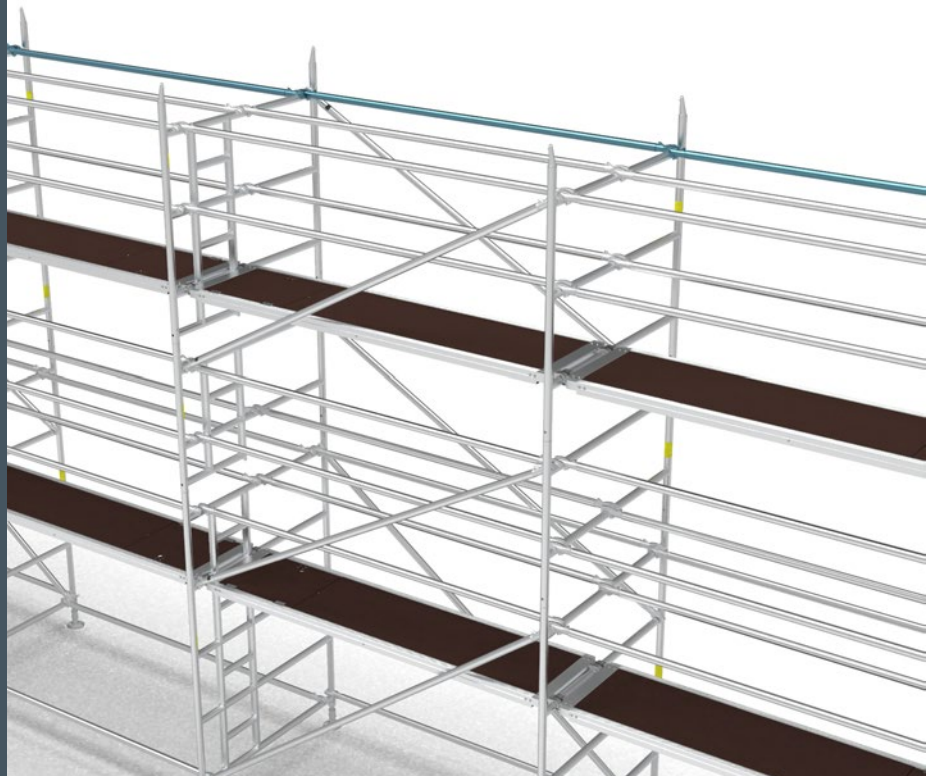

All Platform Heights & Build Method D

Step 11

Start from the first bay, install a 4 rung ladder frame and a walkthrough 'H' frame. Ensure the gate is fully inserted into the walkthrough frame before installing. Then, clip 2 diagonal braces on. The top of the brace should be on the top rung of the newly installed frames - as close the frame uprights as possible. The bottom of the brace should finish on the top rung of the frame below. The brace should be running in the same angled direction as the diagonal braces below. All middle bays will use 2 walkthrough frames, and the opposite end bay will use a 4 rung plain frame and a walkthrough frame.

Step 12

Now, working from the current platform in each bay, install all the platforms for the next level. 1 trap platform is used per level. This is located in the end bay where the ladder frame is on the outside face of the tower. All remaining platforms are plain. Ensure the trap door is located next to the ladder and that the wind latches are fully engaged on all platforms.

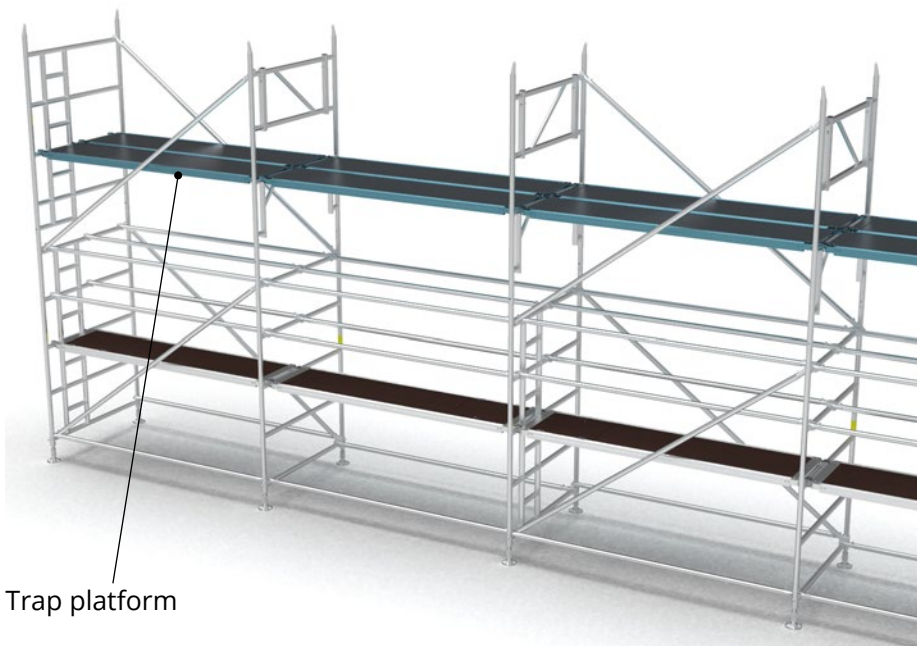
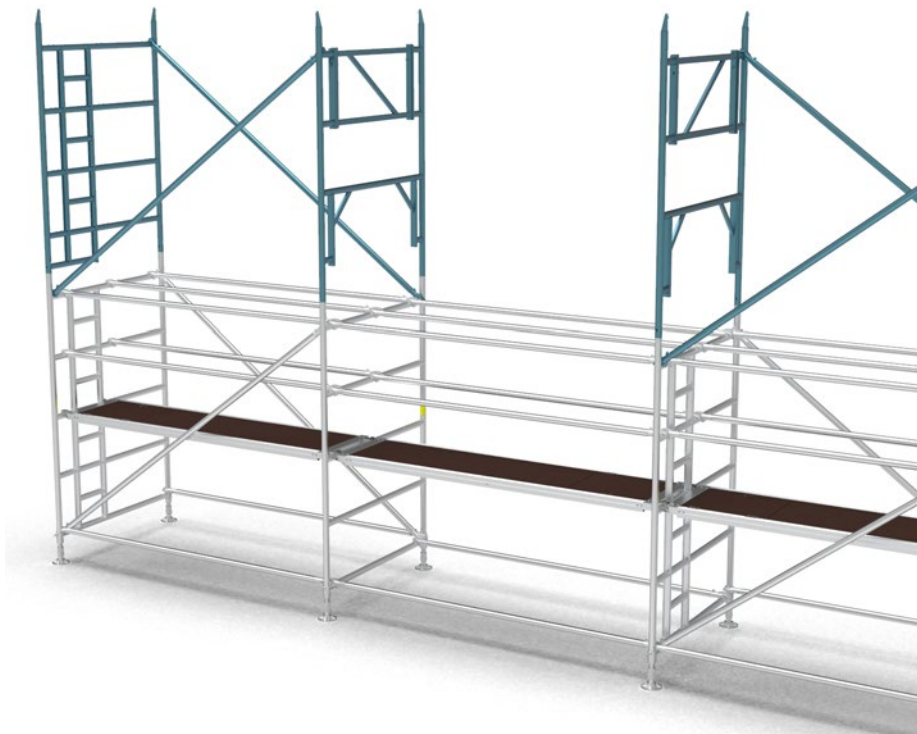

Trap platform

Step 13

Using the 3T method, install 4 guardrails in the first bay only.

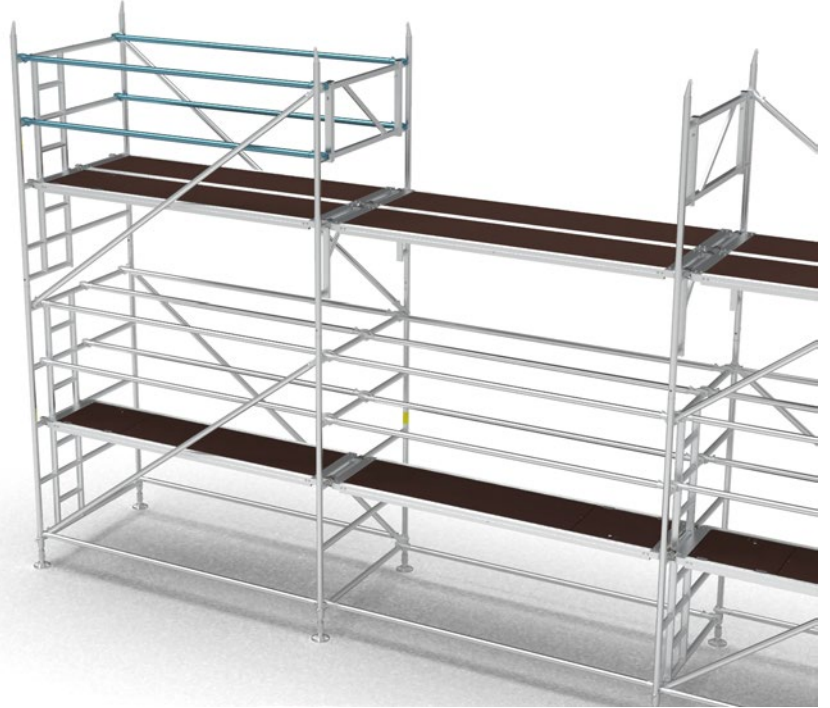

Step 14

Working from the newly guardrailed 1st bay, install another 4 braces as guardrails for the 2nd bay. Once all 4 guardrails are installed, the gate in the first walkthrough frame can be removed and stored safely, ready to be used in the dismantling procedure. Repeat this until all bays in the run are guardrailed.

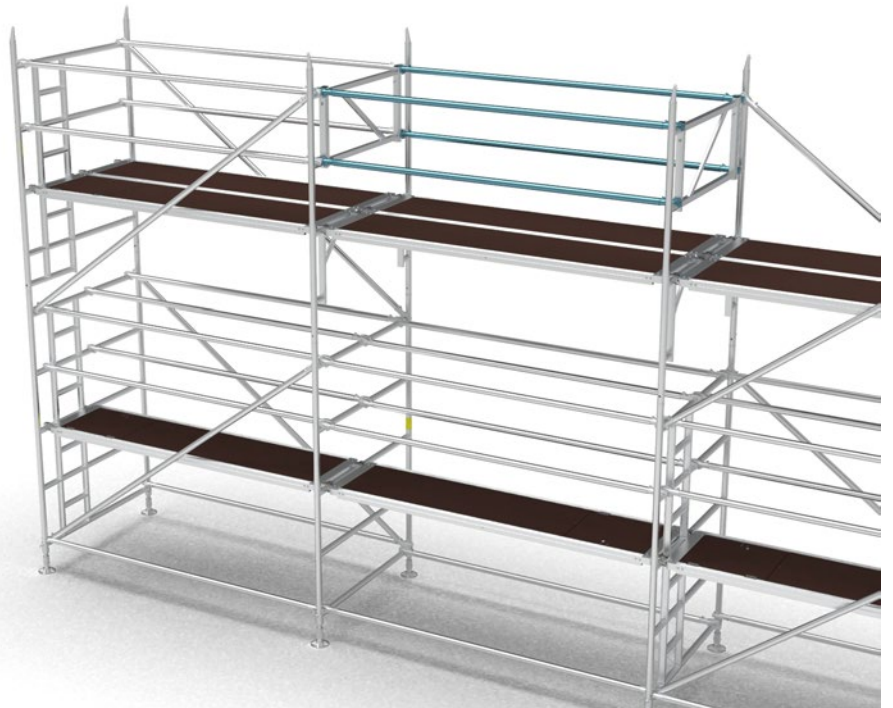



Step 15

Repeat steps 11-14 until the final working platform height is established.

Finally, install the toeboards to all platforms on all working levels.

DISMANTLING INSTRUCTIONS - All Platform Working Heights

The dismantling procedure is the reverse of the assembly procedure and requires a minimum of 2 operatives to complete the task safely. Particular points which must be followed during the dismantling include the following:

- Do not remove stabilisers from the structure until the dismantling process has removed all frames above the base level.
- Remove the toeboard assembly from all working platform levels before removing that level of the tower.
- NEVER STAND ON AN UNGUARDED PLATFORM.

Step 1

The dismantling procedure requires a minimum of 2 operatives to complete the task safely. To start, first remove the toeboard assembly from all working platform levels and disconnect tying in from the highest level only.

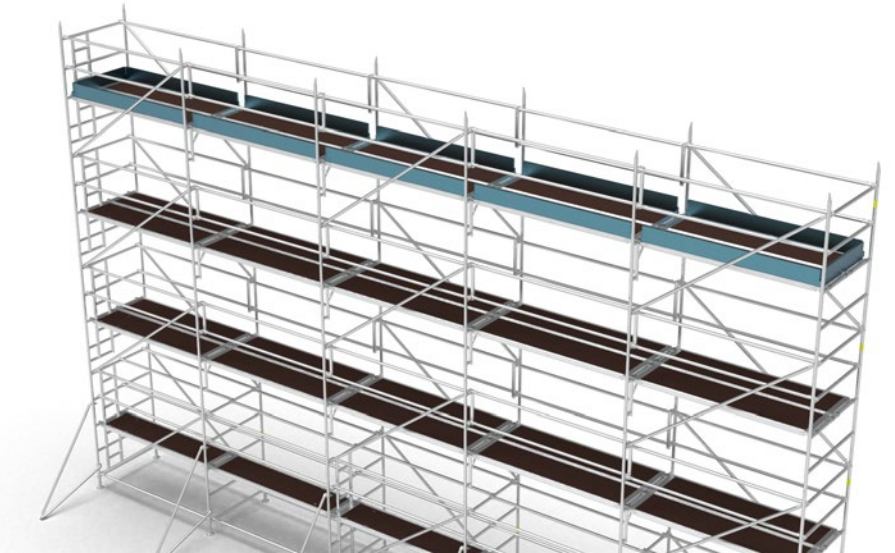

Step 2

Starting at the end of the structure with no ladder frame (if only one ladder frame is installed) relocate the diagonal braces downwards so the top hook is located on the same rung as the uppermost platform - as shown. This can be done by using one operative on the top platform and one operative on the platform underneath.

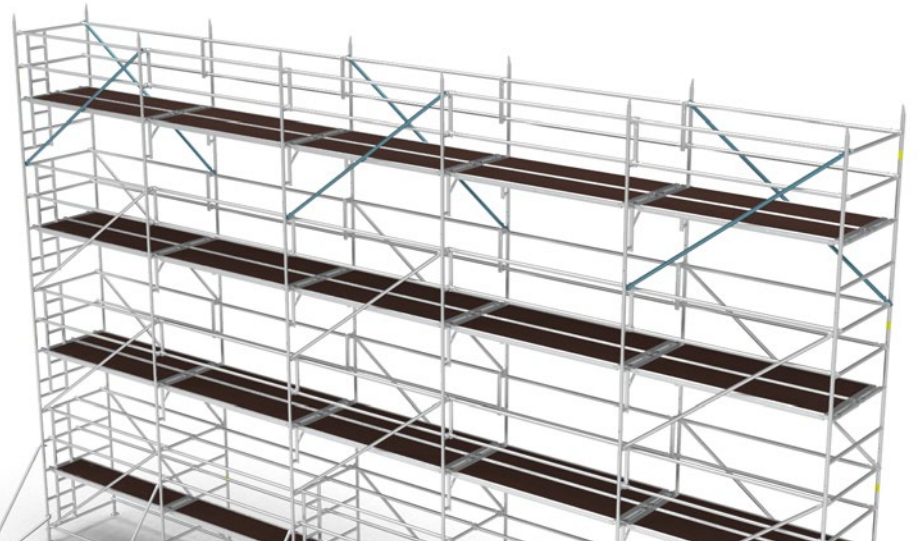



Step 3

Next, unclip the 4 guardrail brace hooks from the end frame **ONLY**. Ensure that all 4 brace hooks are still fully connected at the walkthrough frame end. Once all 4 braces are resting on the frame rung as shown, move directly back to the next bay.

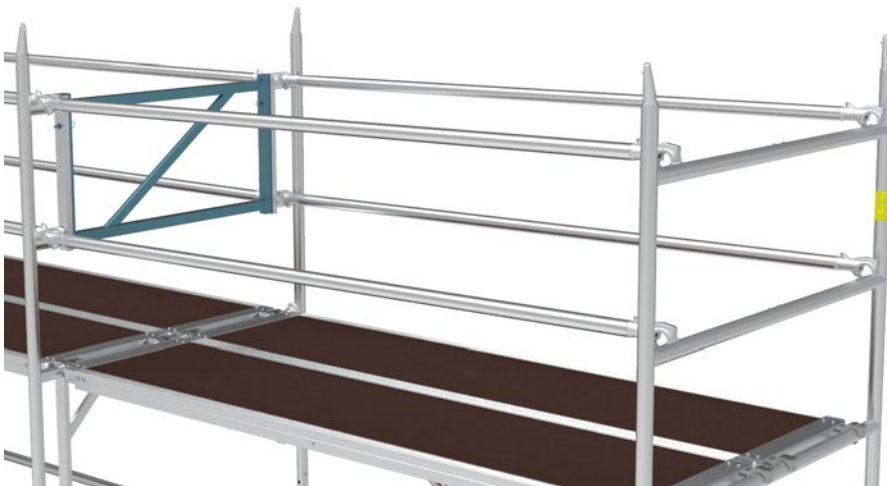

Step 4

Now install the Guard Rail Panel into the walkthrough 'H' Frame. Ensure that the panel is fully engaged and the spring loaded pins are fully located into the holes provided. At this point the panel should not be able to lift out without unlocking the pins.



Step 5

Standing behind the walkthrough gate fitted in step 3, remove the 4 braces that were disconnected at the far end in step 2.

Step 6

Repeat steps 2-5 until all bays except for the final bay has had the guardrails removed.

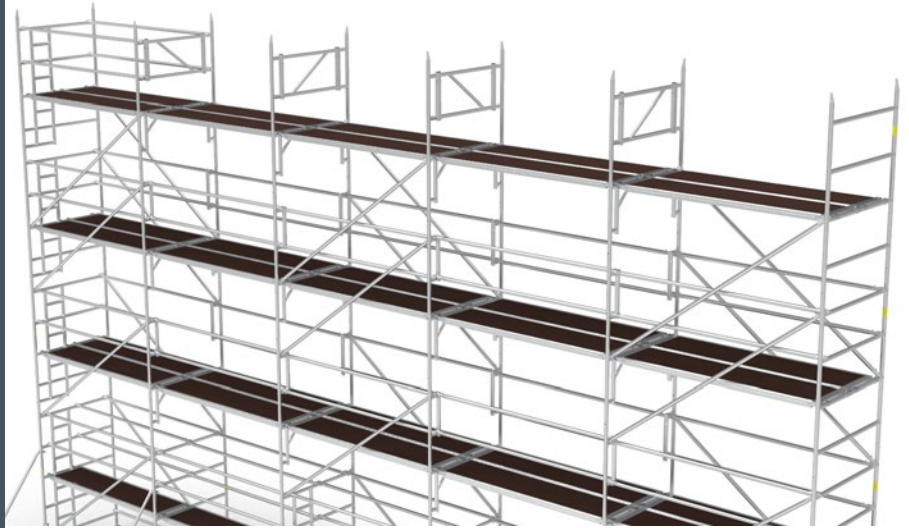

Step 7

In the final bay, remove the 4 guardrails by first disconnecting each brace at the end furthest away from the platform trap door (as done in Step 3). Then immediately take up the protected position in the trap platform detailed in the 3T method. Whilst standing through the trapdoor as per the 3T method, disconnect the braces completely.



Step 8

Now, working from the platforms below, the upper platforms can be removed along the whole structure.

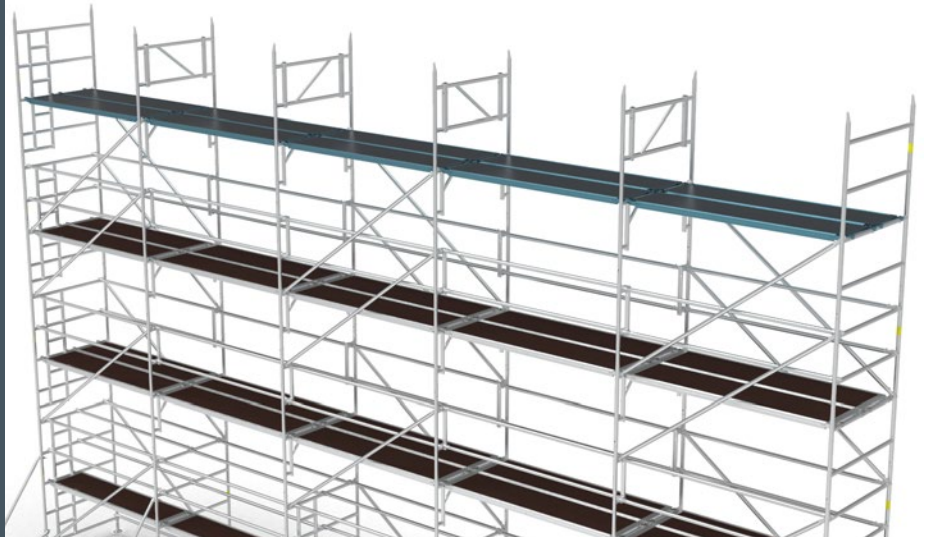

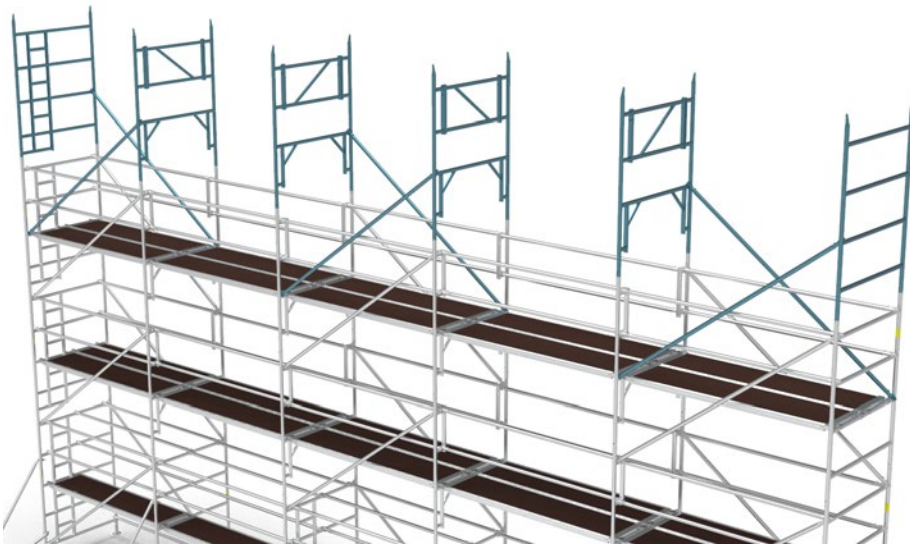

Step 9

The diagonal braces can now be taken off, followed by all the upper frames - as shown.

At this point, repeat steps 1-9 until the structure is dismantled or the new working platform height is achieved.

Components



2233 Swivel Base Jack



2001 1.4m Base Frame



2002 1.4m Main Frame



2006 1.4m 3/4 Frame



2008 1.4m 1/2 Frame

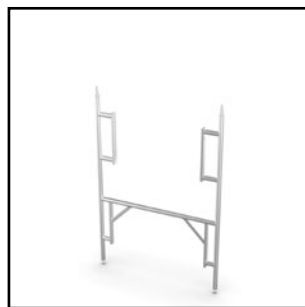

2009 1.4m Walkthrough Frame

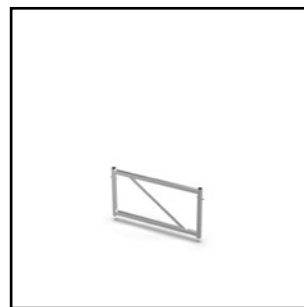

2010 1.4m Walkthrough Frame Gate



2212 1.4m 5 Rung Ladder Frame



2213 1.4m 4 Rung Ladder Frame



2214 1.4m 3 Rung Ladder Frame



2215 1.4m 2 Rung Ladder Frame



2040 1.8m Brace



2041 2.7m Brace



2042 3.3m Brace



2080 1.8m x 3 Rung Brace (Blue)



2083 2.7m x 3 Rung Brace (Black)

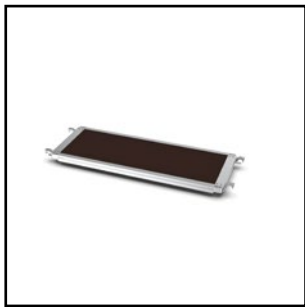

2043 1.8m Plain Platform

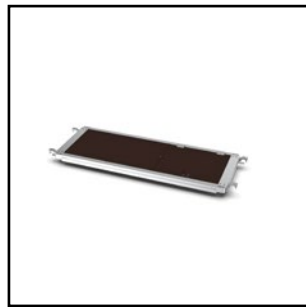

2201 1.8m Trap Platform



2044 2.7m Plain Platform



2202 2.7m Trap Platform



2069 1.8m Timber
Toeboard Side

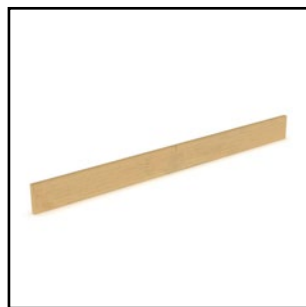

2070 2.7m Timber
Toeboard Side

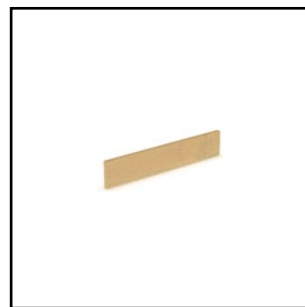

2071 D/W Timber
Toeboard End



2086 1.8m Timber
Toeboard Side - Linked



2087 2.7m Timber
Toeboard Side - Linked

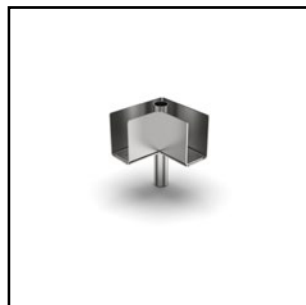

2074 Timber Toeboard
Corner Bracket

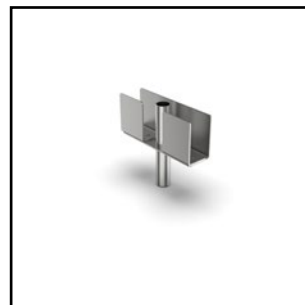

2079 Timber Toeboard
Inline Bracket



2056 Small Stabiliser



2057 Large Stabiliser

THE HEIGHT OF SAFETY

For more information regarding our range of access products and services, please get in touch with us:

Lakeside Industries Ltd

Unit 19 Howard Road, Park Farm Industrial Estate
Redditch, Worcestershire. B98 7SE. UK

t: +44(0)1527 500 577

e: sales@altoaccess.com

w: www.altoaccess.com



@lakesideindust



@altotowers



lakeside-industries-ltd



ISO 9001:2015
Management
System



www.tuv.com
ID 9108630741



ASSOCIATE MEMBER



Manufacturing Member

Lakeside Industries Ltd

Unit 19 Howard Road, Park Farm Industrial Estate, Redditch, Worcestershire. B98 7SE
+44(0)1527 500577 | sales@altoaccess.com | www.altoaccess.com



LAKESIDE
INDUSTRIES